



201919094308



中国认可  
国际互认  
检测  
TESTING  
CNAS L12422

# Type Test Report

Report No.: P201111638

Sample Name : Surge Protective Devices

Model No. : TGE-SPD40K385C/1  
TGE-SPD40K385C/2  
TGE-SPD40K385C/3

Applicant : Xi'an Liangong Electric Co., Ltd.

Issue Date : 2020-12-15

**广东雷宁普电气检测技术有限公司**  
Guangdong LNP Electrical Testing Technology Co., Ltd.

# Statement

1. Report no test report special seal or official seal is invalid.
2. The report has no test, audit, and the approver's signature is invalid.
3. This report may not be copied (except for full text reproduction) without the written approval of the laboratory.
4. Reports are invalid if they are altered.
5. The commissioned test is only responsible for the test results of the tested samples.
6. If there is any objection to the inspection report, it shall be submitted to the inspection unit within 15 days from the date of receipt of the report, and will not be processed within the time limit (based on the postmark date or the date of receipt of the report).

## Communication information

Add: No. 101, Building B, Xinyongsheng Technology Park, Wenquan South Road No. 70, Xinwei Village, Shilong Town, Dongguan City, Guangdong Province, China.

Postcode: 523000

Tel: 0769-81329986

Fax: 0769-81329986

Web: [www.lnptest.com](http://www.lnptest.com)





# 检验检测机构 资质认定证书

证书编号：201919094308

名称：广东雷宁普电气检测技术有限公司

地址：东莞市石龙镇新维村温泉南路70号鑫永盛科技园B栋101号

经审查，你机构已具备国家有关法律、行政法规规定的基本条件和能力，现予批准，可以向社会出具具有证明作用的数据和结果，特发此证。

资质认定包括检验检测机构计量认证。

检验检测能力及授权签字人见证书附表

你机构对外出具检验检测报告或证书的法律 responsibility 由广东雷宁普电气检测技术有限公司承担。

发证日期：2019年04月17日

有效期至：2025年04月16日

发证机关：(印章)



许可使用标志



201919094308

注：需要延续证书有效期的，应当在证书届满有效期3个月前提出申请，不再另行通知。

本证书由国家认证认可监督管理委员会监制，在中华人民共和国境内有效。

首次



China National Accreditation Service for Conformity Assessment  
LABORATORY ACCREDITATION CERTIFICATE  
(Registration No. CNAS L12422 )

**Guangdong LNP Electrical Testing Technology Co., Ltd.**

*(Legal Entity: Guangdong LNP Electrical Testing Technology Co., Ltd.)*

No.101, Building B, Xinyongsheng Technology Park, No.70, Wenquan South  
Road, Xinwei, Shilong, Dongguan, Guangdong, China

***is accredited in accordance with ISO/IEC 17025: 2017 General Requirements for the Competence of Testing and Calibration Laboratories(CNAS-CL01 Accreditation Criteria for the Competence of Testing and Calibration Laboratories) for the competence to undertake the service described in the schedule attached to this certificate.***

***The scope of accreditation is detailed in the attached schedule bearing the same registration number as above. The schedule forms an integral part of this certificate.***

**Effective Date: 2019-07-12**

**Expiry Date: 2025-07-11**

Signed on behalf of China National Accreditation Service for Conformity Assessment

China National Accreditation Service for Conformity Assessment(CNAS) is authorized by Certification and Accreditation Administration of the People's Republic of China (CNCA) to operate the national accreditation schemes for conformity assessment. CNAS is a signatory of the International Laboratory Accreditation Cooperation Mutual Recognition Arrangement (ILAC MRAs) and the Asia Pacific Laboratory Accreditation Cooperation Mutual Recognition Arrangement (APLAC MRAs). The validity of the certificate can be checked on CNAS website at <http://www.cnas.org.cn/english/findanaccreditedbody/index.shtml>



# 委托检测实验室

Subcontracted Testing Laboratory

V-217

广东雷宁普电气检测技术有限公司

经中国质量认证中心评定，被授予委托检测实验室资格。

This laboratory has been granted by China Quality Certification Centre(CQC) as subcontracted testing laboratory.

签署人：

Qi Shuang, Vice President of CQC

有效期至：2025年 8 月 31 日



中国质量认证中心

CHINA QUALITY CERTIFICATION CENTRE

## 网上查询说明

尊敬的客户：

为了方便您推广、更方便您查询，欢迎使用我司查询服务。

1. 扫描下方二维码查询，更加方便快捷。



2. 网站查询：登陆网址 <http://www.lnptest.com>,在“客户服务-证书及报告查询”栏中输入报告编号，即可查询到所需报告的公开信息。

### 证书及报告查询

通过输入证书编号可以查询该产品防雷产品认证证书。

请输入证书编号



立即查询 →

3. 中国国家认证认可监督管理委员会（全国认证认可信息公共服务平台）  
官网报告查询：登陆网址 <http://cx.cnca.cn/CertECloud/qts/qts/qtsPage>，然后在“查询条件中”输入报告编号，即可查询到所需报告的公开信息。

查询条件

报告编号:

广东雷宁普电气检测技术有限公司

咨询电话：0769-81329986

# Type Test Report

Sample Name: Surge Protective Devices Model No.: See page one Brand: <b>TGE</b> Quantity of Samples: 16 pcs Samples Status: function intact Date of Received: 2020-11-11 Date of Started: 2020-11-12 Date of completion: 2020-12-15	Applicant: Xi'an Tiangong Electric Co., Ltd. Address: No.53, Hong Guang Road, He Ping Industrial Park, San Qiao, Xi'an, China. Manufacturer: Xi'an Tiangong Electric Co., Ltd. Address: No.53, Hong Guang Road, He Ping Industrial Park, San Qiao, Xi'an, China. Factory: Xi'an Tiangong Electric Co., Ltd. Address: No.53, Hong Guang Road, He Ping Industrial Park, San Qiao, Xi'an, China.
Test Standards: GB/T 18802.1-2011 Low-voltage surge protective (SPD) Part 1: Surge protective devices connected to low-voltage power distribution systems - Requirements and tests	
Test Results: The product meets the standard requirements and the test is qualified.	
Tester: Anndy Chen Signature: <i>Anndy Chen</i> Date: 2020-12-15 Reviewer: Leo Tong Signature: <i>Leo Tong</i> Date: 2020-12-15 Approver: Eric Zhang Signature: <i>Eric Zhang</i> Date: 2020-12-15	 <b>Guangdong LNP Electrical Testing Technology Co., Ltd.</b> 2020-12-15
Note: The next oversight date is 2022-12-14	

## Samples description and description

## 1. Product composition and structure characteristics

Product structure overview: The product is a surge protector for low-voltage distribution system. The voltage limiting function element of each module is composed of a metal oxide varistor. There is an independent disconnecter on the module. The working principle of the disconnecter is thermal trip. This function is realized by melting the disconnecter at low temperature welding points with spring elastic action. When the disconnecter is in action, the transparent front window of the surge protector will display a red indication

1) Model no. and product name: TGE-SPD40K 385C/1, TGE-SPD40K 385C/2, TGE-SPD40K 385C/3, Surge Protective Devices

## 2) Type of SPD:

- a) SPD Number of ports:  one port;  two ports
- b) SPD design topology:  Voltage switching type;  Voltage limiting type;  Combination type
- c) SPD test categories:  Class I test;  Class II test;  Class III test
- d) SPD location:  Indoor;  Outdoor
- e) SPD accessibility:  Accessible;  Inaccessible
- f) SPD mounting method:  Fixed;  Portable
- g) SPD protection functions:  Thermal;  Leakage current;  Overcurrent
- h) SPD disconnecter Location:  Internal;  External;  Both
- i) SPD if or not multipole SPD:  Yes;  No

## 3) Main components of the product

- a) Terminals:  Screws;  Screwless terminals;  Insulation pierced;  Nuts, plug, socket

Clamped wire and its minimum and maximum cross-sectional areas: Multiple rigid conductors  
4mm<sup>2</sup> -25mm<sup>2</sup>

If the screw type, the nominal thread diameter: 5mm

## b) Housing and base

Name and brand of enclosure material: PBT

Name and brand of base material: PBT

c) Limiting voltage components: MOV

d) Terminal: Copper

e) Fusible metal in disconnecter: low temperature soldering

f) Disconnecter: Copper

## 4) Drawing number

a) General assembly drawing No.: /

b) Electrical schematic diagram No.: /



## Samples description and description

## 2. Main technical parameters

## 2.1 Subject parameters

- 1) Nominal a.c. voltage of the system  $U_0$ : 220 Vac
- 2) Maximum continuous operating voltage  $U_c$ : 385 Vac ( each mode of protection )
- 3) Test type and discharge parameters for each protection mode :
  - Class I test (T1)  $I_{imp}$ : \_\_\_\_\_
  - Class II test (T2)  $I_{max}$ : 40 kA
  - Class III test (T3)  $U_{oc}$ : \_\_\_\_\_
- 4) Class I and Class II nominal discharge current  $I_n$ : 20 kA (each mode of protection)
- 5) Voltage protection level  $U_p$ : 1.5 kV (each mode of protection)
- 6) Short-circuit withstand capability: 300 A
- 7) Total discharge current  $I_{total}$ : \_\_\_\_\_ / \_\_\_\_\_
- 8) Current type: AC
- 9) Number of phase: Single Phase, Three Phases
- 10) IP code: IP20
- 11) Rated follow current: \_\_\_ / \_\_\_ (Only applicable to voltage switching component)
- 12) Rated load current: \_\_\_ / \_\_\_ (tests for two-port SPDs and one port-SPDs with separate input/output terminals)
- 13) Load side surge withstand: \_\_\_ / \_\_\_ (tests for two-port SPDs and one port-SPDs with separate input/output terminals)
- 14) Load side short-circuit withsatand capability : \_\_\_ / \_\_\_ (tests for two-port SPDs and one port-SPDs with separate input/output terminals)
- 15) Voltage drop: \_\_\_\_\_ / \_\_\_\_\_ (This parameter is only used for two-port SPDs. )
- 16) Usage patterns: TN systems
- 17) Temporary overvoltage (TOV) :
  - a) Test under TOVs caused by faults in the high (medium) voltage system
    - TOV failure mode;  TOV withstand mode;  N/A(Not Apply)
  - b) Test under TOVs caused by faults in the low voltage system
    - TOV failure mode;  TOV withstand mode;  N/A(Not Apply)
- 18) Operating and storage temperatures: -40°C to +70°C
- 19) Disengage from action instructions (if any): Red is invalid
- 20) Technical requirements for external SPD disconnectors: \_\_\_ / \_\_\_\_\_
- 21) Specific energy for class I tests only: \_\_\_\_\_ / \_\_\_\_\_

## Samples description and description

## 2.2 Table of main parameters

Class II test (T2) :

Model no.	Modes of protection	$I_{max}$ (kA)	$I_n$ (kA)	$U_c$ (V)	$U_p$ (kV)	Modes of combination
TGE-SPD40 K 385C/1	L/N-PE	40	20	385	1.5	1P
TGE-SPD40 K 385C/2	L/N-PE	40	20	385	1.5	2P
TGE-SPD40 K 385C/3	L/N-PE	40	20	385	1.5	3P



## Samples description and description

## 3. Model Analysis

TGE-SPD40K 385C/1, TGE-SPD40K 385C/2, TGE-SPD40K 385C/3

TGE: Representative band

40: Representative  $I_{max}=40kA$

385: Representative  $U_c=385VAC$

1,2,3: 1P, 2P, 3P Modes of combination

## 4. Special structural description (if any)

No

## 5. Product certification

No

## 6. List of safety items

No	Components name	Key components/Components/ Name of material	Model no.
1	Enclosure	Plastic	PBT
2	Connection terminal	Cooper	/
3	Voltage-limiting	MOV	/
4	Fusible metal in disconnecter	Low temperature solder wire	/
5	Disconnecter	Cooper	/

Note: When the key parts/components/materials of safety parts are not limited to one manufacturer, one model and one set of technical parameters, all relevant items should be tested repeatedly.

Samples description and description

7. Product profile photos

1) Appearance



TGE-SPD40K385C/1



TGE-SPD40K385C/2

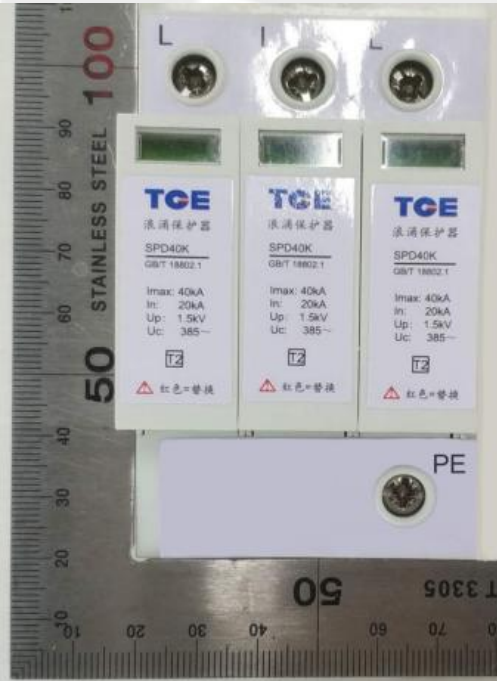

TGE-SPD40K385C/3

Samples description and description

2) Marking

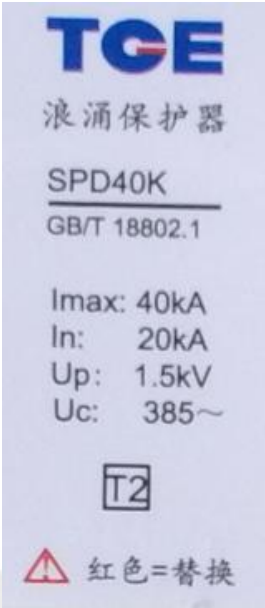

## Table of Test items

items	Test items	Subclause	Samples No.	Result
I/01	Identification and marking	6.1.1/6.1.2/7.2	1, 2, 3	P
02	Terminals and connections	6.2.1/6.3/7.3		P
03	Testing for protection against direct contact	6.5/7.4		N/A
04	Standby power consumption and residual current	6.5.3/6.5.4/7.7.5		P
II/05	Protection level	6.2.2/7.5	4, 5, 6	P
III/06	Operating duty test	6.2.6/7.6	4, 5, 6	P
IV/07	Class I and II total discharge current	6.5.6/7.9.10	/	N/A
V/08	Test of thermal stability	6.2.7/7.7.2	7, 8, 9	P
VI/09	Short-circuit with capability test	6.2.7/6.2.11/7.7.3	10, 11, 12	P
VII/10	TOV test	6.2.7/6.5.5/7.7.6	/	N/A
11	TOV test	6.2.7/6.5.5/7.7.4		N/A
VIII/12	Flexible cables and cords and their connection	7.9.1	13, 14, 15	N/A
13	Mechanical strength	6.3/6.5.1.1/7.9.2.1		P
14	Mechanical strength	6.3/6.5.1.1/7.9.2.2		N/A
15	Insulation resistance	6.5.1/7.9.7		P
16	Dielectric withstand	6.2.10/7.9.8		P
17	Environment, IP code	6.4/6.5.1/7.9.9		P
18	Heat resistance	6.5.1.2/7.9.3		P
19	Air clearances and creepage distances	6.2.8/7.9.5.1		P
20	Resistance to abnormal heat and fire	6.5.2/7.9.4		P
21	Trcaking resistane	6.2.9/7.9.6		N/A
IX/22	Percentage voltage regulation	6.6.1/7.8.1	/	N/A
23	Rated load current	6.6.2/7.8.1		N/A
24	Load side surge withstand	6.6.3/7.8.4		N/A
25	Overload behaviour	6.6.4/7.8.5		N/A
26	Load side short-circuit withstand capability test	6.2.7/7.8.3		N/A
X/27	Status indicator operation	6.2.12	/	N/A
28	Isolation between separate circuits	6.2.13		N/A
blank below				

Clause	Requirement - Test	Result - Remark	Verdict
<b>TEST SERIES 1</b>			
6.1.1/6.1.2	<b>Identification and Marking</b>		P
	Marking are mandatory on the body, or permanently attached to the body, of the SPD.	See below	P
	a) Manufacturer/Trade mark/Model number	Trade mark: <b>TCE</b> Model number: TGE-SPD40K 385C/1, TGE-SPD40K 385C/2, TGE-SPD40K 385C/3	P
	e) Maximum continuous operating voltage UC (one value for each mode of protection)	385 Vac	P
	f) Test classification and discharge parameters shall be printed next to each other for each mode of protection declared by the manufacturer	L/N-PE	P
	For test class I: either "test class I" and "Iimp" and the value in kA, or "T1" (T1 in a square) and "Iimp" and the value in kA		N/A
	For test class II: either "test class II" and "I <sub>max</sub> " and the value in kA, or "T2" (T2 in a square) and "I <sub>max</sub> " and the value in kA	<span style="border: 1px solid black; padding: 2px;">T2</span> 40 kA	P
	For test class III: either "test class III" and "UOC" and the value in kV, or "T3" (T3 in a square) and "UOC" and the value in kV		N/A
	g) Nominal discharge current I <sub>n</sub> for class I and II (one value for each mode of protection)	20 kA	P
	h) Voltage protection level UP (one value for each mode of protection)	1.5 kV	P
	j) Degree of protection provided by the enclosure > IP20	IP20	N/A
	l) Maximum recommended ratings of overcurrent protection (if applicable)		N/A
	o) Identification of terminals (if necessary)	L/ N/ PE	P
	q) Type of current: a.c. frequency or d.c., or both	a.c.	P
	The following minimum information shall be provided by the manufacturer:	See below	P
	b) Location category	Indoor	P
	c) Number of ports	One port	P
	d) Method of mounting	Fixed	P
	i) Rated load current I <sub>L</sub>	One port	N/A
	k) Short-circuit withstand	300A	P
	m) Indication of disconnecter operation (if any)		N/A
	n) Position of normal use if significant		N/A
	p) Installation instructions (e.g. connection to LV systems, mechanical dimensions, lead lengths, etc.)	SPD connection to TN systems	P
	r) Specific energy W/R for class I test only		N/A
	s) Temperature range	-40°C ~ +70°C	P
	t) Follow current interrupting rating I <sub>fi</sub> (except in the case of voltage limiting type SPDs)		N/A
	u) The external SPD disconnecter requirements shall be defined by the manufacturer		N/A
	v) Residual current IPE (optional)	0.5mA	P
	w) Temporary overvoltage (TOV) characteristic		P

Clause	Requirement - Test	Result - Remark	Verdict
	x) Total discharge current I <sub>Total</sub> for multipole SPDs (if declared by the manufacturer).	No declared by the manufacturer	N/A
	Marking shall be indelible and legible and shall not be placed on screws and removable washers.		P
7.2.2	<b>Test of indelibility of markings</b>		P
	This test shall be applied on markings of all types except those made by impressing, molding and engraving. The test is made by rubbing the marking by hand for 15 s with a piece of cotton soaked with water and again for 15 s with a piece of cotton soaked with aliphatic solvent hexane (with a content of aromatics of maximum 0,1 % volume, a kauributanol value of 29, initial boilingpoint approximately 65 °C and specific gravity of 0,68 g/cm <sup>3</sup> ).		P
	After this test, the marking shall be easily legible.	Marking was easily legible	P
6.2.1/7.3	<b>Terminals and connections</b>		P
	Terminals shall be designed for the connection of cables having a minimum and a maximum cross-sectional area according to the manufacturer declaration.	minimum 4 mm <sup>2</sup> maximum 25 mm <sup>2</sup>	P
	The SPD shall be equipped with terminals where electrical connection is possible by means of screws, nuts, plugs, sockets or equal effective means.	Screws	P
7.3.1	The SPD is mounted according to the manufacturer's recommendation, and is protected against undue external heating or cooling.		P
	Unless otherwise specified, the SPD terminals (3 samples of each construction used) shall be wired with conductors according to – Table 6 for two-port devices and one-port devices with separate input/output terminals, – the manufacturer's instruction for other one-port devices, and fixed on a dull, black-painted wood board of about 20 mm thickness. The method of fixing shall comply with any requirements relating to the means of mounting recommended by the manufacturer.	minimum 4 mm <sup>2</sup> maximum 25 mm <sup>2</sup>	P
	During the test, no maintenance or dismantling of the sample is allowed.		P
7.3.2	<b>Terminals with screws</b>		P
7.3.2.1	<b>Test of reliability of screws, current-carrying parts and connections</b>		P
	The screws are tightened and loosened —ten times for screws in engagement with a thread of insulating material, —five times in all other cases.	5 times	P
	Screws or nuts in engagement with a thread of insulating material are completely removed and reinserted each time unless the construction of the screw prevents this.		N/A
	The test is made by means of a suitable test	5 mm φ	P



Clause	Requirement - Test	Result - Remark	Verdict
	screwdriver or spanner applying a torque as shown in Table 5.	2.0 Nm	
	The conductor is moved each time the screw is loosened.		P
	During the test, the screwed connections shall not work loose and there shall be no damage, such as breakage of screws or damage to the head slots, threads, washers or stirrups, that will impair the further use of the SPD.		P
	Moreover, enclosures and covers shall not be damaged verification by visual inspection.		P
7.3.2.2	<b>Test of reliability of terminals for external conductors</b>		P
	These tests are made by means of a suitable screwdriver or spanner applying a torque as shown in Table 5.	5 mm $\phi$ 2.0 Nm	P
7.3.2.2.1	The terminals are fitted with copper conductors of the smallest or largest cross sectional areas specified in 7.3.1, solid or stranded, whichever is most unfavourable.	minimum 4 mm <sup>2</sup> maximum 25 mm <sup>2</sup>	P
	The conductor is inserted into the terminal for the minimum distance prescribed or, where no distance is prescribed, until it just projects from the far side, and in the position most likely to assist the wire to escape.		P
	The clamping screws are then tightened with a torque equal to two-thirds of that shown in the appropriate column of Table 5.	5 mm $\phi$ 1.3 Nm	P
	Each conductor is then subjected to a pull of the value, in newtons, shown in Table 7. The pull is applied without jerks, for 1 min, in the direction of the axes of the conductor space.	100 N	P
	During this test, the conductor shall not move noticeably in the terminal.		P
7.3.2.2.2	The terminals are fitted with copper conductors of the smallest or largest cross sectional areas specified in 7.3.1 solid or stranded, whichever is the most unfavourable	minimum 4 mm <sup>2</sup> maximum 25 mm <sup>2</sup>	P
	The terminal screws are tightened with a torque equal to two-thirds of that shown in the appropriate column of Table 5.	5 mm $\phi$ 1.3 Nm	P
	The terminal screws are then loosened and the part of the conductor which may have been affected by the terminal is inspected.		P
	During the test, terminals shall not work loose and there shall be no damage such as breakage of screws or damage to the head slots, threads, washers or stirrups, that will impair the further use of the terminal.		P
7.3.2.2.3	The terminals are fitted with a rigid stranded copper conductor conforming to Table 8.	minimum 4 mm <sup>2</sup> maximum 25 mm <sup>2</sup>	P
	The conductor is inserted into the terminal until the conductor reaches the bottom of the terminal or just projects from the far side of the terminal and in the position most likely to assist a wire to escape.		P
	The clamping screw or nut is then tightened with a torque equal to two-thirds of that shown in the appropriate column of Table 5.	5 mm $\phi$ 1.3 Nm	P
	After the test, no wire of the conductor shall have escaped from the SPD terminal.		P

Clause	Requirement - Test	Result - Remark	Verdict
7.3.3	<b>Screwless terminals</b>		N/A
	The terminals are fitted with new conductors of the type and of the minimum and maximum cross-sectional areas as specified in 7.3.1, solid or stranded, whichever is the most unfavourable.		N/A
	Each conductor is then subjected to a pull of the value shown in the following Table 9. The pull is applied without jerks for 1 min in the direction of the axis of the conductor.		N/A
	During the test there shall be no movement of the conductor in the terminal or any indication of damage.		N/A
7.3.4	<b>Insulation pierced connections</b>	Without Insulation pierced connections	N/A
7.3.4.1	<b>Pull out test on SPD terminals designed for single core conductors</b>		N/A
	The terminals are fitted with new copper conductors of the smallest or largest cross-sectional area specified in 7.3.1. solid or stranded, whichever is most unfavourable.		N/A
	Screws, if any, are tightened according to Table 5.		N/A
	The conductors are connected and disconnected five times, new conductors being used each time.		N/A
	After each connection the conductors are subjected to a pull, without jerks, for 1 min in the axis of the tapping conductor according to the value given in Table 9.		N/A
	During the test, there shall be no movement of the conductor in the terminal or any sign of damage.		N/A
7.3.4.2	<b>Pull out test on SPD terminals designed for multi-core cables or cords</b>	Without Insulation pierced connections	N/A
	The pull-out test on the SPD terminals designed for multi-core cables or cords is carried out according to 7.3.4.1 except that the pull force is applied to the entire multicore cable or cord instead of to the individual core.		N/A
	if any, are tightened according to Table 5.		N/A
	The pull force is calculated according to the following formula: $F = F(x)\sqrt{n}$ where : F —is the total force to apply; ; N —is the number of cores; ; F(x) —is the force for one core according to the cross-section of one conductor (see Table 9).		N/A
	During the test, the cable or cord shall not slip out of the terminals.		N/A
7.3.5	<b>Nuts, plug, socket</b>	Without nuts, plug, socket	N/A
	Compliance is checked by inspection and trial mounting.		N/A
6.3.2	<b>Mechanical connections</b>		P
	Terminals shall be fastened to the SPD in such a way that they will not work loose if the clamping screws or the lock nuts are tightened or loosened. A tool shall be required to loosen the		P

Clause	Requirement - Test	Result - Remark	Verdict
	clamping screws or the lock nuts.		
	Plugs and socket outlets shall correspond to the relevant national requirements, and those clauses of GB 2099.1 that may apply.	Without plugs and socket outlets	N/A
	Screws, current-carrying parts and connections		P
	1) Connections, whether electrical or mechanical, shall withstand the mechanical stresses occurring in normal use. .		P
	Screws operated when mounting the SPD during installation shall not be of the thread cutting type.	Without thread cutting type	P
	2) Electrical connections shall be so designed that contact pressure is not transmitted through insulating material other than ceramic, pure mica or other material with characteristics no less suitable, unless there is sufficient resilience in the metallic parts to compensate for any possible shrinkage or yielding of the insulating material.		P
	3) Current-carrying parts and connections including parts intended for protective conductors, if any, shall be of either: —copper, or —an alloy containing at least 58 % copper for parts worked cold, or at least 50 % copper for other parts, or —other metal or suitably coated metal, no less resistant to corrosion than copper and having mechanical properties no less suitable.	At least 58 % copper	P
	Terminals with screw for external conductors		P
	1) Terminals for external conductors shall be such that the conductors may be connected so as to ensure that the necessary contact pressure is maintained permanently.		P
	Such arrangements may be either of the plug-in or of the bolt-on type.		P
	The terminals shall be readily accessible under the intended conditions of use.		P
	2) The means for clamping the conductors in the terminals shall not serve to fix any other component, although they may hold the terminals in place or prevent them from turning.		P
	3) Terminals shall have adequate mechanical strength. Screws and nuts for clamping the conductors shall have a metric ISO thread or a thread comparable in pitch and mechanical strength. Provisionally, SI, BA and UN threads may be used as they are virtually equivalent in pitch and mechanical strength to metric ISO threads.	M5 Screws	P
	4) Terminals shall be so designed that they clamp the conductor without undue damage to the conductor.	without undue damage to the conductor.	P
	5) Terminals shall be so designed that they clamp the conductor reliably and between		P

Clause	Requirement - Test	Result - Remark	Verdict
	metal surfaces.		
	6) Terminals shall be so designed or positioned that neither a rigid solid conductor nor a wire of a stranded conductor can slip out while the clamping screws or nuts are tightened.		P
	7) Terminals shall be so fixed or located that, when the clamping screws or nuts are tightened or loosened, the terminals shall not work loose from their fixings to the SPDs. These requirements do not imply that the terminals shall be so designed that their rotation or displacement is prevented, but any movement shall be sufficiently limited so as to prevent non-compliance with the requirements of this standard.		P
	The use of sealing compound or resin is considered to be sufficient for preventing a terminal from working loose, provided that —the sealing compound or resin is not subject to stress during normal use, and —the effectiveness of the sealing compound or resin is not impaired by temperatures attained by the terminal under the most unfavorable conditions specified in this standard.		N/A
	8) Clamping screws or nuts of terminals intended for the connection of protective conductors shall be adequately secured against accidental loosening.		P
	Screwless terminals for external conductors	Without Screwless terminals	N/A
	Terminals shall be so designed and constructed that —each conductor is clamped individually. During the connection or disconnection the conductors can be connected or disconnected either at the same time or separately; —it is possible to clamp securely any number of conductors up to the maximum provided.		N/A
	2) Terminals shall be so designed and constructed that they clamp the conductor without undue damage to the conductor		N/A
	Insulation pierced connections for external conductors		N/A
	1) The insulation pierced connections shall make a reliable mechanical connection.		N/A
	2) Screws for making contact-pressure shall not serve to fix any other component, although they may hold the SPD in place or prevent it from turning.		N/A
	3) Screws shall not be of metal which is soft or liable to creep.		N/A
6.3.3	<b>Corrosive resistant metals</b>		P
	Clamps, except clamping screws, lock nuts, binding clip thrust washers, wire, and similar, shall consist of corrosion resistant metal such as copper, brass, etc. (see IEC 60999).		P
6.5.1	<b>rotection against direct contact</b>	Fixed SPD, out of reach	N/A

Clause	Requirement - Test	Result - Remark	Verdict
	These requirements are valid for accessible SPDs where the maximum continuous operating voltage $U_c$ is above 50 V r.m.s. a.c. or d.c.		N/A
	For protection against direct contact (inaccessibility of live parts), SPDs shall be designed in such a way that live parts cannot be touched when the SPD is installed for the intended use. Compliance is verified by standardized test methods of GB 4208 and to 7.4.		N/A
	SPDs, except SPDs classified as inaccessible, shall be so designed that, when they are wired and mounted as for normal use, live parts are not accessible, even after removal of parts which can be removed without the use of a tool.		N/A
7.4.1	<b>Insulated parts</b>		N/A
	The sample is mounted as for normal use and the test is conducted using conductors of the smallest cross-sectional area and then again using conductors of the largest cross-sectional area as specified in 7.3.1.		N/A
	The standard test finger (in accordance with GB 4208) is applied in every possible position.		N/A
	For plug-in SPDs (which can be changed without a tool), the test finger is applied in every possible position, when the plug is partially engaged or completely engaged with a socket outlet.		N/A
	An electrical indicator with a voltage of not less than 40 V and not more than 50 V is used to show contact with the relevant part.		N/A
7.4.2	<b>Metal parts</b>		N/A
	Metal parts which are accessible when the SPD is wired and mounted as for normal use have to be connected to earth through a low resistance connection, except of small screws and the like, isolated from live parts, for fixing bases and covers or cover plates of socket-outlets.		N/A
	A current (derived from an a.c. source having a no-load voltage not exceeding 12 V) equal to 1,5 times the rated load current or 25 A, whichever is the greater, is passed between the earthing terminal and each of the accessible metal parts in turn.		N/A
	The voltage drop between the earthing terminal and the accessible metal part is measured and the resistance is calculated from the current and this voltage drop.		N/A
	The resistance shall not exceed 0,05 $\Omega$ .		N/A
6.5.3/6.5.4/ 7.7.5	<b>Standby power consumption and residual current test</b>	See below	P
	The SPD is connected to a voltage source at its maximum continuous operating voltage ( $U_c$ ) in accordance with the manufacturer's instructions. The apparent power (volt-amperes) consumed by the SPD is measured. The residual current flowing through the PE terminal is measured. NOTE 1 If the manufacturer allows more than one configuration for the SPD installation, this test should be performed for every configuration. NOTE 2 The true r.m.s. current value should be measured.	$U_c=385$ Vac apparent power: 102.025mVA $I_{PE} = 0.265$ mA < 0.5 mA (declared by the manufacturer )	P

Clause	Requirement - Test	Result - Remark	Verdict
Remark:			



Clause	Requirement - Test	Result - Remark	Verdict												
<b>TEST SERIES 2</b>															
6.2.2	<b>Protection level</b>		P												
	The measured limiting voltage of SPDs shall not exceed the voltage protection level that is specified by the manufacturer.	Up=1.5kV	P												
7.5	Class I and II SPD To avoid overstress of the samples, the test of 7.5.2 is performed only at $I_n$		P												
	Class I and II SPD with switching component: Test of 7.5.3 the sparkover voltage, measured limiting voltage (five of positive and five of negative polarity) should less than $U_P$ .		P												
	Class III SPD Test of 7.5.4 or 7.5.5 needs to be carried out at $U_{oc}$ only, four surges will be applied to the SPD at each amplitude: two of positive and two of negative polarity	Class II SPD	N/A												
	All one-port SPDs shall be tested unenergized.		P												
	All two-port SPDs are to be tested energized by means of a voltage source having a nominal current of at least 5 A at $U_c$	One port SPD	N/A												
	For a one-port SPD having terminals, the test is performed without external disconnectors and the measured limiting voltage is measured at the terminals. For a one-port SPD having connecting leads, the measured limiting voltage is measured with an external lead length of 150 mm.		P												
	For a two-port SPD, and a one-port SPD having separate load terminals, the measured limiting voltage is measured at the load port or load terminals of the SPD.		N/A												
	The measured limiting voltage is the highest voltage value	highest voltage value 1.47kV See annex 1 and 2	P												
7.5.2	<b>Test procedure to measure the residual voltage with 8/20 current impulses</b>	See below	P												
	The 8/20 current impulses shall be used with a sequence of peak values of approximately 0.1 $I_n$ 0.2 $I_n$ 0.5 $I_n$ 1.0 $I_n$ If the SPD contains only voltage-limiting components, this test needs only to be performed at $I_n$ .	SPD contains only voltage-limiting components, this test needs only to be performed at $I_n$ . $I_n=20$ kA unit: kV <table border="1" style="margin-left: auto; margin-right: auto;"> <thead> <tr> <th></th> <th>#1</th> <th>#2</th> <th>#3</th> </tr> </thead> <tbody> <tr> <td>1.0 <math>I_n</math></td> <td>1.44</td> <td>1.45</td> <td>1.47</td> </tr> <tr> <td>-1.0 <math>I_n</math></td> <td>1.46</td> <td>1.46</td> <td>1.47</td> </tr> </tbody> </table>		#1	#2	#3	1.0 $I_n$	1.44	1.45	1.47	-1.0 $I_n$	1.46	1.46	1.47	P
	#1	#2	#3												
1.0 $I_n$	1.44	1.45	1.47												
-1.0 $I_n$	1.46	1.46	1.47												
	One sequence of positive polarity and one sequence of negative polarity are applied to the SPD.		P												
	Finally, at least one impulse of $I_{max}$ or $I_{peak}$ providing $I_{max}$ or $I_{peak}$ is above $I_n$ is applied to the SPD at the polarity that showed higher residual voltages in previous tests.	$I_{max}=40$ kA	P												
	The interval between individual impulses shall be long enough for the sample to cool down to ambient temperature.		P												
	A current and a voltage oscillogram shall be recorded for each impulse. T		P												

Clause	Requirement - Test	Result - Remark	Verdict
	The (absolute) peak values shall be plotted into a discharge current versus residual voltage diagram.		P
	The residual voltage used for determining the measured limiting voltage is given by definition as the highest voltage on this curve corresponding in the range of currents for: – class I: up to $I_{peak}$ or $I_n$ whichever is greater; – class II: up to $I_n$ .	class II: up to $I_n$ .	符合
7.5.3	<b>est procedure to measure the front-of-wave sparkover voltage</b>	Without switching compoments	N/A
	The 1,2/50 voltage impulse is used. The generator voltage is set to an open circuit output voltage of 6 kV.		N/A
	10 impulses are applied to the SPD, five of positive and five of negative polarity.		N/A
	The interval between individual impulses shall be long enough to allow the sample to cool down to ambient temperature.		N/A
	If sparkover is not observed during any of the 10 impulses on the front of the wave, then a) and b) above are repeated with a generator open circuit output voltage of 10 kV.		N/A
	The voltage at the SPD shall be recorded with an oscilloscope.		N/A
	The measured limiting voltage is the maximum value of the sparkover voltages recorded during the whole test sequence.		N/A
7.5.4	<b>Test procedure to measure the limiting voltage with the combination wave</b>	class II SPD	N/A
	The combination wave will be applied to an energized SPD, with the mains voltage at $U_c$ .		N/A
	For SPDs rated <i>only</i> on a.c. power systems, positive impulses are applied at the $90^\circ \pm 10^\circ$ point and negative impulses at $270^\circ \pm 10^\circ$ point on the sinusoidal voltage waveform.		N/A
	For SPDs rated for use on d.c. systems, both positive and negative impulse surges are applied. The SPD will be energized at the d.c. $U_c$ .		N/A
	The interval between the individual impulses shall be long enough for the sample to cool down to ambient temperature.		N/A
	The voltage of the combination wave generator is set to provide an open-circuit voltage of 0.1 $U_{oc}$ 0.2 $U_{oc}$ 0.5 $U_{oc}$ 1.0 $U_{oc}$ If the SPD only contains voltage-limiting components this test needs to be carried out at $U_{oc}$ only.		N/A
	With these generator settings four surges will be applied to the SPD at each amplitude: two of positive and two of negative polarity.		N/A
	An oscillographic record shall be made of the current delivered by the generator into the SPD and the voltage at the output port of the SPD for each impulse.		N/A



Clause	Requirement - Test	Result - Remark	Verdict
	The measured limiting voltage is the maximum magnitude of the peak voltage recorded during the whole test sequence.		N/A
Remark:			



Clause	Requirement - Test	Result - Remark	Verdict
<b>TEST SERIES 3</b>			
6.2.6/7.6	<b>Operating duty test</b>	Test Series 2 samples are used for series 3 tests	P
	Measured limiting voltage		P
	Class I and II SPD To avoid overstress of the samples, the test of 7.5.2 is performed only at $I_n$	Class II SPD	P
	Class I and II SPD with switching component: Test of 7.5.3 the sparkover voltage, measured limiting voltage (five of positive and five of negative polarity) should less than $U_P$ .	SPD without switching	N/A
	Class III SPD Test of 7.5.4 or 7.5.5 needs to be carried out at $U_{oc}$ only, four surges will be applied to the SPD at each amplitude: two of positive and two of negative polarity	Class II SPD	N/A
7.6.3	<b>Power frequency source characteristics for preconditioning</b>		P
	The test sample shall be connected to a power frequency voltage $U_c$	385 Vac	P
	<b>SPDs with follow current below 500 A</b> The test sample shall be connected to a power frequency voltage source. The impedance of the power source shall be such that during the flow of follow current the peak value of the power frequency voltage, measured at the SPD terminals, does not fall below the peak value of its $U_c$ by more than 10 %.		P
	<b>SPDs with follow current above 500 A</b> The test sample shall be connected to a power frequency voltage $U_c$ with a prospective shortcircuit current equal to the follow current interrupt rating $I_n$ declared by the manufacturer in accordance with Table 11, or 500 A, whichever is greater. For SPDs connected between neutral and protective earth only, the prospective short-circuit current shall be at least 100 A.		N/A
7.6.4	<b>Class I and II preconditioning tests</b>		P
	Fifteen 8/20 current impulses of positive polarity shall be applied in three groups of five impulses. The test samples are connected to a power source according to 7.6.3. Each impulse shall be synchronized to the power frequency. Starting from 0° the synchronization angle shall be increased in steps of $30^\circ \pm 5^\circ$ intervals  — When testing SPDs to class I, current impulses with values equal to $I_{peak}$ or $I_n$ , whichever is greater, are applied. — When testing SPDs to class II, current impulses with values equal to $I_n$ , are applied.	synchronization angle 0°, 30°, 60°, 90°, 120°, 150°, 180°, 210°, 240°, 270°, 300°, 330°, 0°, 30°, 60°  $I_n=20$ kA	P
	The current shall be recorded at each impulse and the current records shall show no sign of puncture or flashover of the samples.		P
7.6.7/7.6.4	Class III preconditioning tests	Class II SPD	N/A

Clause	Requirement - Test	Result - Remark	Verdict
	For the operating duty test of class III SPDs, a power frequency voltage source according to 7.6.3 is used. Fifteen $U_{oc}$ impulses of positive polarity shall be applied in three groups of five impulses. The current impulse shall be initiated at the peak value of the corresponding half cycle and in the same polarity of the power frequency voltage. The interval between the impulses is 50 s – 60 s, the interval between the groups 25 min – 30 min.		N/A
	The current shall be recorded at each impulse and the current records shall show no sign of puncture or flashover of the samples.		N/A
7.6.5	<b>Class I and II operating duty test</b>	Class II SPD	P
	The SPD is energized at $U_c$ by means of a voltage source having a nominal current capability of at least 5 A.	385 Vac	P
	The power frequency voltage remains applied for 30 min after each impulse to prove the thermal stability: the SPD is considered to be thermally stable if the peak of the resistive component of $I_c$ , or the power dissipation steadily decreases during the last 15 min of $U_c$ voltage application.		P
	Current impulses of positive polarity shall be initiated in the corresponding positive peak value of the power frequency voltage source to the energized test sample as follows. :	$I_{max} = 40$ kA See annex 3	P
	0.1 $I_{peak}$ (or $I_{max}$ ) 0.25 $I_{peak}$ (or $I_{max}$ ) 0.5 $I_{peak}$ (or $I_{max}$ ) 0.75 $I_{peak}$ (or $I_{max}$ ) 1.0 $I_{peak}$ (or $I_{max}$ )		
	cool down to ambient temperature.		P
7.6.7	<b>Class III operating duty test</b>	Class II SPD	N/A
	The SPD is energized at $U_c$ by means of a voltage source having a nominal current capability of at least 5 A.		N/A
	The power frequency voltage remains applied for 30 min after each impulse to prove the thermal stability: the SPD is considered to be thermally stable if the peak of the resistive component of $I_c$ , or the power dissipation steadily decreases during the last 15 min of $U_c$ voltage application.		N/A
	using the combination wave generator with the following generator settings $U_{oc}$ , One positive and one negative impulse :		N/A
	0.1 $U_{oc}$ 0.25 $U_{oc}$ 0.5 $U_{oc}$ 0.75 $U_{oc}$ 1.0 $U_{oc}$		
	check thermal stability; cool down to ambient temperature.		N/A
7.6.6	<b>Pass criteria</b>	see below	P

Clause	Requirement - Test	Result - Remark	Verdict									
	thermal stability is achieved after each impulse of the operating duty test	thermal stability is achieved after each impulse	P									
	The SPD has passed the test if any follow current is self-extinguished	follow current is self-extinguished	P									
	Both the voltage and current records, together with a visual inspection, shall show no indication of puncture or flashover of the samples	no indication of puncture or flashover of the samples	P									
	Mechanical damage shall not occur during these tests.	No mechanical damage	P									
	One more impulse at $I_n$ or $U_{oc}$ shall be applied to the SPD while energized at $U_c$ by means of a voltage source having a nominal current capability of at least 5 A. After this impulse, $U_c$ remains applied and thermal stability shall be achieved within 30 min.	thermal stability	P									
	Once thermal stability is achieved, either: —the current, which flows through the test sample, is measured. Its resistive component (measured at the crest of the sine wave) shall not exceed a value of 1 mA; or —the stand-by power consumption shall not increase by more than 20 % of the value measured in 7.7.5.		P									
	Type I and Type II SPD: this test needs only to be performed at $I_n$ .	Unit: kV <table border="1"> <thead> <tr> <th>#1</th> <th>#2</th> <th>#3</th> </tr> </thead> <tbody> <tr> <td>1.44</td> <td>1.46</td> <td>1.45</td> </tr> <tr> <td>-1.47</td> <td>-1.48</td> <td>-1.46</td> </tr> </tbody> </table>	#1	#2	#3	1.44	1.46	1.45	-1.47	-1.48	-1.46	P
#1	#2	#3										
1.44	1.46	1.45										
-1.47	-1.48	-1.46										
	Type III SPD: this test needs only to be performed at $U_{oc}$ .	Type II SPD	N/A									
	The SPD has passed the test, if the values measured before and after the test are below or equal to $U_p$ .	$U_p = 1.5kV$	P									
7.7.1	<b>Operating duty withstand test of SPD disconnectors</b>		P									
	The SPD disconnector(s) is(are) tested during the operating duty test (see 7.6). The disconnectors, as specified by the manufacturer, shall not operate during the test and shall be in working order after this test.	disconnector didn't operated	P									
Remark:												

Clause	Requirement - Test	Result - Remark	Verdict
<b>TEST SERIES 4</b>			
7.9.10	<b>Total discharge current test for multipole SPDs</b>		N/A
	One side of the test generator is connected to the PE or PEN terminal of the multipole SPD. Each of the remaining terminals is connected via a typical series impedance consisting of a resistance of 30 mΩ and an inductance of 25 μH, to the other side of the generator.		N/A
	The multipole SPD shall be tested once with the total discharge current $I_{Total}$ declared by the manufacturer.		N/A
	<b>Pass criteria</b>		N/A
	Each mode of the test sample is then connected to $U_c$ . The test transformer shall have a short-circuit current capability of at least 200 mA. The current, which flows through the test sample, is measured. Its resistive component (measured at the crest of the sine wave) shall not exceed a value of 1 mA or the stand-by power consumption shall not increase by more than 20 % of the value measured in 7.7.5.		N/A
	Test for Class I and II SPD The test of 7.5.2. is performed only at $I_n$		N/A
	Test for Class I and II SPD with switching components: The test of 7.5.3 <b>front-of-wave sparkover voltage</b>		N/A
	Measured limiting voltage shall be determined using the tests described in 7.5 to check if the voltage protection level specified by the manufacturer has been maintained.		N/A
	Auxiliary circuits, like status indicators, shall be in working order.		N/A
	Visual inspection of the test sample shall reveal no evidence of any damage.		N/A
Remark:			

Clause	Requirement - Test	Result - Remark	Verdict
<b>TEST SERIES 5</b>			
7.7.2	<b>Test of thermal stability of SPDs</b>		P
7.7.2.1	<b>Temperature withstand test</b>		P
	The SPD is kept in a heated cabinet at an ambient temperature of 80 °C ± 5 K for 24 h.	80°C, 24 h	P
	No internal SPD disconnecter shall operate during this time.	Internal SPD disconnecter didn't operated	P
7.7.2.2	<b>Thermal stability test</b>		P
	This test is not performed on SPDs containing only voltage switching components.		N/A
	Any voltage switching component, which is connected in series with a voltage limiting component, shall be short-circuited by a copper wire with a diameter such that it does not melt during the test.		N/A
	For SPDs with different non-linear components connected in parallel, this test has to be performed for every current path of the SPD by disconnecting/interrupting all the remaining current paths. If components of the same type and parameters are connected in parallel, they shall be tested as one current path.		N/A
	<b>a) Test procedure for SPDs having no switching component in series with other components</b>		P
	The test samples shall be connected to a power frequency source. The voltage shall be high enough to allow a current to flow through the SPD. For this test, the current is set to a constant value. The tolerance for the test current is ±10 %. The test is started at a value of 2 mA r.m.s.		P
	The starting point may be changed from 2 mA to a current corresponding to the maximum power dissipation of the component, if it is known. 2 mA 4 mA 6 mA 8 mA 10 mA 12 mA 14 mA 16 mA 18 mA 20 mA	mm:ss 17:18 23:49 25:52 20:12 25:02 25:23 22:44 17:52 12:17 03:36 see annex 4	P
	Each step is maintained until thermal equilibrium is reached (i.e. variation of temperature less than 2 K within 10 min).		P
	The surface temperature on the hottest spot of the SPD (for accessible SPDs only) and the current through the SPD are monitored continuously.		P

Clause	Requirement - Test	Result - Remark	Verdict
	This test is interrupted if all non-linear components under test are disconnected. The voltage shall not be increased further in order to avoid any malfunction of the disconnecter.		P
	If the voltage across the SPD falls below $U_c$ during the test, the current regulation is discontinued and the voltage is adjusted back to $U_c$ and maintained for a duration of 15 min. Continuous current monitoring is therefore no longer required. The source shall have a short-circuit current capability which will not limit the current before any disconnecter operates. The maximum available current value shall not exceed the short circuit withstand capability declared by the manufacturer.	V kA cos $\phi$ =	N/A
	<b>b) Test procedure for SPDs having a switching component in series with other components</b>	With switching component	N/A
	The SPD is energized with a power frequency source at $U_c$ and having a short-circuit current capability which will not limit the current before any disconnecter operates. The maximum available current value shall not exceed the short-circuit withstand capability declared by the manufacturer.		N/A
	If no significant current flows, test procedure a) shall be followed.		N/A
	<b>Pass criteria</b>		P
	<i>Indoor SPDs:</i> The surface temperature rise shall be less than 120 K during the test. The surface temperature shall not exceed 80 K above ambient temperature 5 min after the disconnecter has operated. During the test, there shall be no expulsion of solid material.	Ambient: 32.1°C surface temperature rise : 104°C-23.5°C=80.5 K<120 K, temperature 5 min after: 84.5°C-23.5°C=61.0K<80 K, no expulsion of solid material.	P
	<i>Outdoor SPDs</i> There shall be no evidence of burning and there shall be no expulsion of solid material.		N/A
	<i>Accessible SPDs:</i> After the test, SPDs having an IP degree equal or greater than IP20 shall not have live parts accessible with the standardized test finger applied with a force of 5 N (see IEC 60529), except the live parts which were already accessible before the test when the SPD is fitted as in normal use.	No accessible SPD	N/A
	If a disconnecter operates, there shall be clear evidence of effective and permanent disconnection by the device. To check this, a power frequency voltage equal to $U_c$ shall be applied for 1 min without current flow in excess of 0,5 mA r.m.s.	385 Vac 0 mA	P
Remark:			

Clause	Requirement - Test	Result - Remark	Verdict
<b>TEST SERIES 6</b>			
6.2.11/7.7.3	<b>Short-circuit withstand capability</b>		P
	This test is not applied to SPDs, which are either: classified for outdoor use and mounted out of reach, or for connection N-PE in TN- and/or TT-systems only		N/A
	The test sample shall be mounted in accordance with the manufacturer's published recommendations and connected with conductors of the maximum cross section according to 7.3.1, keeping the cables inside the box to a maximum length of 0,5 m each		P
	The SPD itself and its disconnectors shall be placed in the centre of a cube shaped wooden box with sides that are (500 ± 50) mm away from the SPD external surfaces.		P
	The internal surface of the box is covered with muslin paper or cheese cloth. One of the box sides (not the bottom one) remains open in order that the supply cables can be connected according to the manufacturer's instructions.		P
	<b>Sample preparations</b>		P
	For SDs with non-linear components connected in parallel, separate sets of three samples shall be prepared in the manner described below for every current path of the SPD, which contains one or more non-linear components described in 3.4 and 3.5 Voltage limiting components and voltage switching components described in 3.4 and 3.5 shall be replaced by appropriate copper blocks, (dummies), ensuring that the internal connections and their cross-section and surrounding material (e.g. resins) and packaging are not changed. .		P
	<b>Test procedure</b>		P
	This test shall be performed at two different test settings with a separate set of prepared test samples for each setting a) and b):		P
	<b>a) Test of the declared short circuit withstand capability:</b>		N/A
	The sample is connected to a power frequency source at $U_C$ , having a prospective short circuit current according to the declared short-circuit withstand capability and power factor according to Table 11.		N/A
	The test is carried out twice with the short-circuit initiated at 45 electrical degrees and at 90 electrical degrees after the zero crossing of the voltage. If a replaceable or resettable internal or external disconnector operates, the relevant disconnector shall be replaced or reset each time. If the disconnector cannot be replaced or reset, the test is stopped.		N/A
	<b>b) Test at low short-circuit current</b>		P



Clause	Requirement - Test	Result - Remark	Verdict
	A power frequency source at $U_c$ , having a prospective short-circuit current of five times the rated current of the maximum overcurrent protection (if declared by the manufacturer), and a power factor according to Table 11, shall be applied for $5 \pm 0,5$ s. If no external overcurrent protection is required by the manufacturer, a prospective short-circuit current of 300 A is used. The test is carried out once with the short-circuit initiated at 45 electrical degrees after the zero crossing of the voltage.	prospective short-circuit current is 300 A, power factor 0.95.	P
	<b>Pass criteria</b>		P
	During the above two short-circuit tests, neither the muslin paper nor the cheese cloth shall catch fire.	Internal disconnecter no operation	P
	<i>Internal and/or special disconnectors not covered by another IEC standard:</i> If they operate there shall be clear evidence of effective and permanent disconnection. To check this, a power frequency voltage equal to $U_c$ shall be applied for 1 min to the disconnector(s) having operated. The current flow shall not exceed 0,5 mA r.m.s.	385 Vac 0 mA	P
	During the above two short-circuit tests, neither the muslin paper nor the cheese cloth shall catch fire.	No fire	P
	<i>Accessible SPDs:</i> After the test, SPDs having an IP degree equal or greater than IP20 shall not have live parts accessible with the standardized test finger applied with a force of 5 N (see IEC 60529), except for those live parts which were already accessible before the test when the SPD is fitted as in normal use.	No accessible SPD	N/A
7.7.3.1	<b>Additional test for SPDs with <math>I_n</math> lower than the declared short-circuit withstand capability</b>		N/A
	The tests according to 7.7.3 are repeated but without voltage switching components being short-circuited. The short-circuit is initiated by triggering the SPD with a positive surge current (8/20 or other appropriate waveshape) at 30 to 40 electrical degrees after the zero crossing of the voltage on the positive half wave. The surge current shall be high enough to initiate a follow current but shall in no case exceed $I_n$ .		N/A
	To ensure that no external disconnector operates due to the trigger surge, all external disconnectors shall be placed in series with the power frequency source as shown in Figure 6a.		N/A
	<b>Test procedure</b>		N/A
	This test shall be performed at two different test settings with a separate set of prepared test samples for each setting a) and b):		N/A

Clause	Requirement - Test	Result - Remark	Verdict
	a) The sample is connected to a power frequency source at $U_c$ , having a prospective short circuit current according to the declared short-circuit withstand capability and power factor according to Table 11		N/A
	The test is carried out twice with the short-circuit initiated at 45 electrical degrees and at 90 electrical degrees after the zero crossing of the voltage. If a replaceable or resettable internal or external disconnecter operates, the relevant disconnecter shall be replaced or reset each time. If the disconnecter cannot be replaced or reset, the test is stopped.		N/A
	b) A power frequency source at $U_c$ , having a prospective short-circuit current of five times the rated current of the maximum overcurrent protection (if declared by the manufacturer), and a power factor according to Table 11, shall be applied for $5\text{ s} \pm 0,5\text{ s}$ . If no external overcurrent protection is required by the manufacturer, a prospective short-circuit current of 300 A is used. The test is carried out once with the short-circuit initiated at 45 electrical degrees after the zero crossing of the voltage.		N/A
	<b>Pass criteria</b>		N/A
	during the test for the short circuit withstand capability, the power short-circuit current shall be interrupted by one of the disconnectors (internal or external) required by the manufacturer.		N/A
	<i>Internal and/or special disconnectors not covered by another IEC standard:</i> If they operate there shall be clear evidence of effective and permanent disconnection. To check this, a power frequency voltage equal to $U_c$ shall be applied for 1 min to the disconnecter(s) having operated. The current flow shall not exceed 0,5 mA r.m.s.		N/A
	The muslin paper or cheese cloth shall not catch fire during the test.		N/A
	<i>Accessible SPDs</i> After the test, SPDs having an IP degree equal or greater than IP20 shall not have live parts accessible with the standardized test finger applied with a force of 5 N (see IEC 60529), except for those live parts which were already accessible before the test when the SPD is fitted as in normal use.		N/A
Remark:			

Clause	Requirement - Test	Result - Remark	Verdict
<b>TEST SERIES 7</b>			
7.7.6	<b>Test under TOVs caused by faults in the low voltage system</b>		P
	If $U_c$ is greater or equal to $U_T$ there is no need to perform this test.	$U_c=385V > U_T=320V$ , no need to perform this test	P
7.7.6.1	<b>Test procedure</b>		N/A
	New samples shall be used and fitted as in normal use, according to the manufacturer's instructions.		N/A
	The SPD shall be mounted in a cube shaped wooden box as described 7.7.3. The internal surface of the box shall be covered with muslin paper or cheese cloth. One of the box sides (not the bottom) shall remain open in order that the supply cables can be connected according to the manufacturer's instructions.		N/A
	The test sample shall be connected for a duration of $t_T = 5 \text{ s } 50 + \%$ to a power frequency voltage of $U_{T0} 5 - \%$ as given in Table B.1, or greater TOV-voltages which the manufacturer has declared in accordance with item 6.6.1. This voltage source shall be capable of delivering a current either high enough to ensure that the voltage at the SPD terminals does not fall below $U_T - 5 \%$ during the test, or equal to the declared short-circuit withstand of the SPD, whichever is lower.		N/A
	Immediately following the application of $U_T$ , a voltage equal to $U_{CS0} 5\%$ with the same current capability, shall be applied to the test sample for a period of 15 min. The time interval between the test periods shall be as short as possible and shall in any case not exceed 100 ms.		N/A
7.7.6.2	<b>Pass criteria</b>		N/A
	The muslin paper or cheese cloth shall not catch fire during the test.		N/A
	SPDs having an IP degree equal or greater than IP20 shall not have live parts accessible with the standardized test finger applied with a force of 5 N (see IEC 60529), except for those live parts which were already accessible before the test when the SPD is fitted as in normal use.		N/A
	TOV failure mode If the manufacturer claims a TOV failure mode, the following additional pass criteria shall be fulfilled: If a disconnecter has operated, there shall be clear evidence of effective and permanent disconnection by the device. To check this, a power frequency voltage equal to $U_C$ shall be applied for 1 min without current flow in excess of 0,5 mA r.m.s.		N/A

Clause	Requirement - Test	Result - Remark	Verdict
	<p>TOV withstand mode            —The SPD shall maintain thermal stability during the application of <math>U_{CS}</math> (following the application of <math>U_T</math>). The SPD is considered to be thermally stable if the current flowing through it or its power dissipation does not continue to increase during the total time of application of <math>U_{CS}</math>            —The test sample is then connected to <math>U_C</math>. The test transformer shall have a short circuit current capability of at least 200 mA .            The current, which flows through the test sample, is measured. Its resistive component (measured at the crest of the sine wave) shall not exceed a value of 1 mA or            the stand-by power consumption shall not increase by more than 20 % of the value measured in 7.7.5.</p>		N/A
	<p>Class I and II SPD            To avoid overstress of the samples, the test of 7.5.2 is performed only at <math>I_n</math></p>		N/A
	<p>Class I and II SPD with switching component:            Test of 7.5.3 the sparkover voltage, measured limiting voltage (five of positive and five of negative polarity) should less than <math>U_P</math>.</p>		N/A
	<p>Class III SPD            Test of 7.5.4 or 7.5.5 needs to be carried out at <math>U_{oc}</math> only, four surges will be applied to the SPD at each amplitude: two of positive and two of negative polarity</p>		N/A
	<p>Auxiliary circuits, like status indicators, shall be in working order.</p>		N/A
	<p>Visual inspection of the test sample shall reveal no evidence of any damage</p>		N/A
7.7.4	<p><b>Test under TOVs caused by faults in the high (medium) voltage system</b></p>	TN system	N/A
	<p>SPDs connected to PE and for use on power distribution systems shall be tested at <math>U_T</math> in accordance with 7.7.4 and Table B.1.</p>		N/A
	<p>New samples shall be used and fitted as in normal use, according to the manufacturer's instructions, and connected to a test circuit according to Figure 13 or equivalent.</p>		N/A
	<p>The SPD shall be mounted in a cube-shaped wooden box as described in 7.7.3. The internal surface of the box shall be covered with muslin paper or cheese cloth. One of the box sides (not the bottom) shall remain open in order that the supply cables can be connected according to the manufacturer's instructions.</p>		N/A

Clause	Requirement - Test	Result - Remark	Verdict
	<p><math>U_T</math> <math>\pm 0/-5</math> % is applied to the test sample at 90 electrical degrees of phase L1 by closing switch S1. After 200 ms 100+% switch S2 is closed automatically. This connects the SPD's PE terminal to the neutral (via the current limiting resistor R2) by short-circuiting the TOV transformer's (T2) secondary winding. This results in the operation of fuse F2 protecting the TOV transformer.</p> <p>The prospective short circuit current of the power source for <math>U_{CS}</math> shall be equal to five times the rated current of the maximum overcurrent protection declared by the manufacturer, or 300 A if no maximum overcurrent protection is declared. The tolerance for the current is 100+%.</p>		N/A
	<b>Pass criteria</b>		N/A
	The muslin paper or cheese cloth shall not catch fire during the test.		N/A
	SPDs having an IP degree equal or greater than IP20 shall not have live parts accessible with the standardized test finger applied with a force of 5 N (see IEC 60529), except for those live parts which were already accessible before the test when the SPD is fitted as in normal use.		N/A
	<p>TOV failure mode</p> <p>If the manufacturer claims a TOV failure mode, the following additional pass criteria shall be fulfilled:</p> <p>If a disconnecter has operated, there shall be clear evidence of effective and permanent disconnection by the device. To check this, a power frequency voltage equal to <math>U_C</math> shall be applied for 1 min without current flow in excess of 0,5 mA r.m.s.</p>		N/A
	<p>TOV withstand mode</p> <p>—The SPD shall maintain thermal stability during the application of <math>U_{CS}</math> (following the application of <math>U_T</math>). The SPD is considered to be thermally stable if the current flowing through it or its power dissipation does not continue to increase during the total time of application of <math>U_{CS}</math>.</p> <p>—The test sample is then connected to <math>U_C</math>. The test transformer shall have a short circuit current capability of at least 200 mA. The current, which flows through the test sample, is measured. Its resistive component (measured at the crest of the sine wave) shall not exceed a value of 1 mA.</p> <p>or</p> <p>the stand-by power consumption shall not increase by more than 20 % of the value measured in 7.7.5.</p>		N/A
	<p>Class I and II SPD</p> <p>To avoid overstress of the samples, the test of 7.5.2 is performed only at <math>I_n</math></p>		N/A

Clause	Requirement - Test	Result - Remark	Verdict
	Class I and II SPD with switching component: Test of 7.5.3 the sparkover voltage, measured limiting voltage (five of positive and five of negative polarity) should less than $U_P$ .		N/A
	Class III SPD Test of 7.5.4 or 7.5.5 needs to be carried out at $U_{oc}$ only, four surges will be applied to the SPD at each amplitude: two of positive and two of negative polarity		N/A
	Auxiliary circuits, like status indicators, shall be in working order.		N/A
	Visual inspection of the test sample shall reveal no evidence of any damage.		N/A
Remark:			



Clause	Requirement - Test	Result - Remark	Verdict
<b>TEST SERIES 8</b>			
7.9.1	<b>Portable SPDs with flexible cables and cords and their connection</b>	Fixed SPD, without flexible cables and cords	N/A
7.9.1.1	Portable SPDs shall be provided with a cord anchorage such that the conductors are relieved from strain, including twisting, where they are connected to the terminals or terminations, and that their covering is protected from abrasion.		N/A
7.9.1.2	The effectiveness of the retention is checked by the following test by means of an apparatus as shown in Figure 8.		N/A
	Non-rewireable SPDs are tested as delivered; the test is made on new samples.		N/A
	Rewireable SPDs are tested with the cable having the nominal cross-sectional area as declared by the manufacturer.		N/A
	Conductors of the flexible cable or cord of rewireable accessories are introduced into the terminals, screws being tightened just sufficiently to prevent the position of the conductors from easily changing.		N/A
	The cord anchorage is used in the normal way, clamping screws, if any, being tightened with a torque equal to two-thirds of that specified in Table 12.		N/A
	After reassembly of the sample, the component parts shall fit snugly and it shall not be possible to push the cable or cord into the sample to any appreciable extent.		N/A
	The sample is placed in the test apparatus so that the axis of the cable or cord is vertical where it enters the sample.		N/A
	The cable or cord is then subjected 100 times to a pull of —60 N if the rated current is not more than 16 A and the rated voltage is up to and including 250 V; —80 N if the rated current is not more than 16 A and the rated voltage is above 250 V; —100 N if the rated current is more than 16 A. The pulls are applied practically without jerks each time for 1 s. Care shall be taken to exert the same pull on all parts (core, insulation and sheath) of the flexible cable simultaneously.		N/A
	For measurement of the longitudinal displacement, a mark is made on the cable or cord while it is subjected to the pull, at a distance of approximately 20 mm from the end of the sample or the cord guard, before starting the tests. If, for non-rewireable accessories, there is no definite end to the sample or the cord guard, an additional mark is made on the body of the sample.		N/A
	After these tests, the displacement of the mark on the cable or cord in relation to the sample or the cord guard is measured while the cable or cord is subjected to the pull.		N/A

Clause	Requirement - Test	Result - Remark	Verdict
	<p>the cable or cord shall not have been displaced by more than 2 mm.</p> <p>For rewireable accessories, the end of the conductors shall not have moved noticeably in the terminals; for non-rewireable accessories, there shall be no break in the electrical connections.</p>		N/A
7.9.1.3	<p>Non-rewireable SPDs shall be provided with a flexible cable or cord complying with GB/T 5023 and GB/T 5013 with a cross-sectional area of the conductors suitable for the maximum rating of the SPD and associated equipment.</p> <p>Compliance is checked by inspection, by measurement, and by checking that the flexible cables or cords are in accordance with GB/T 5023 and GB/T 5013, as applicable.</p>		N/A
7.9.1.4	<p>Non-rewireable SPDs shall be so designed that the flexible cable or cord is protected against excessive bending where it enters the accessory.</p>		N/A
	<p>Guards provided for this purpose shall be of insulating material and shall be fixed in a reliable manner. Helical metal springs, whether bare or covered with insulating material, shall not be used as core guards.</p>		N/A
	<p>Compliance is checked by inspection and by a flexing test made by means of an apparatus as shown in Figure 10.</p> <p>The test is made on new samples.</p>		N/A
	<p>The sample is fixed to the oscillating mechanism of the apparatus. Therefore when it is in mid-position, the axis of the flexible cable or cord where it enters the sample is vertical; thus passing through the axis of oscillation.</p> <p>The accessory is, by variation of the distance between the fixed part of the oscillating mechanism and the axis of oscillation, so positioned that the cord makes the minimum lateral movement when the oscillating mechanism of the test apparatus is moved over its full length of travel.</p> <p>In order to have the possibility of finding easily by experiment the mounting position with the minimum lateral movement of the cord during the test, the flexing apparatus should be built in such a way that the different supports for the accessories mounted on the oscillating mechanism can be readily adjusted.</p>		N/A
	<p>The cable or cord is loaded with a mass such that the force applied is</p> <ul style="list-style-type: none"> <li>—20 N for accessories with cables or cords having a nominal cross-sectional area exceeding 0,75 mm<sup>2</sup>;</li> <li>—10 N for other accessories.</li> </ul>		N/A



Clause	Requirement - Test	Result - Remark	Verdict
	A current equal to the rated current for the accessory or the following current, whichever is the lower, is passed through the conductors: —16 A for accessories with cables or cords having a nominal cross-sectional area exceeding 0,75 mm <sup>2</sup> ; —10 A for accessories with cords having a nominal cross-sectional area of 0,75 mm <sup>2</sup> ; —2,5 A for accessories with cords having a nominal cross-sectional area less the 0,75 mm <sup>2</sup> .		N/A
	The voltage between the conductors is equal to the rated voltage of the sample.		N/A
	The oscillating mechanism is moved through an angle of 90° (45° on either side of the vertical), the number of flexings being 10 000 and the rate of flexing 60 per minute.		N/A
	Samples with circular section cables or cords are turned through 90° in the oscillating mechanism after 5 000 flexings, samples with flat cords are only bent in a direction perpendicular to the plane containing the axes of the conductors.		N/A
	During the flexing test, there shall be —no interruption of the current, —no short-circuit between conductors. A short-circuit between the conductors of the flexible cable or cord is considered to occur if the current attains a value equal to twice the test current of the accessory.		N/A
	The voltage drop between each contact and the corresponding conductor, with a test current flowing having a value of the rated current, shall not exceed 10 mV.		N/A
	After the test the guard, if any, shall not have separated from the body and the insulation of the flexible cable or cord shall show no sign of abrasion or wear; broken strands of the conductor shall not have pierced the insulation so as to become accessible.		N/A
6.5.1.1 / 7.9.2	<b>Mechanical strength</b>		P
7.9.2.1	SPDs shall have adequate mechanical strength so as to withstand the stresses imposed during installation and use.		P
	The samples are subjected to strikes by means of an impact-test apparatus as shown in Figure 11.		P
	The samples are mounted on a sheet of plywood, 8 mm thick and 175 mm square, secured at its top and bottom edges to a ridged bracket.		P
	Portable SPDs are tested as fixed SPDs, but they are fixed to the plywood sheet by auxiliary means.	Fixed SPD	N/A
	Flush-type SPDs are mounted in a recess provided in a block of hornbeam or material having similar mechanical characteristics, which is fixed to a sheet of plywood. (They are not tested in their relevant mounting boxes.)	Fixed SPD	N/A
	Flush-type screw fixing SPDs shall be fixed by means of screws to lugs recessed in the block.	Fixed SPD	N/A

Clause	Requirement - Test	Result - Remark	Verdict						
	Flush-type claw fixing SPDs shall be fixed to the block by means of the claws.	Fixed SPD	N/A						
	Before applying the strikes, fixing screws of bases and covers are tightened with a torque equal to two-thirds of that specified in Table 12.		P						
	<p>The samples are mounted so that the point of impact lies in the vertical plane through the axis of the pivot.</p> <p>The striking element is allowed to fall from a height which is specified in the following Table 13.</p> <table border="0" data-bbox="319 515 909 616"> <tr> <td>A and B</td> <td>h=100mm</td> </tr> <tr> <td>C</td> <td>h=150mm</td> </tr> <tr> <td>D</td> <td>h=200mm</td> </tr> </table> <p>A—parts on the front surface, including parts which are recessed.</p> <p>B—parts which do not project more than 15 mm from the mounting surface (distance from the wall) after mounting as in normal use, with the exception of the above parts A.</p> <p>C—parts which project more than 15 mm and not more than 25 mm from the mounting surface (distance from the wall) after mounting as in normal use, with the exception of the above parts A.</p> <p>D—parts which project more than 25 mm from the mounting surface (distance from the wall) after mounting as in normal use, with the exception of the above parts A.</p>	A and B	h=100mm	C	h=150mm	D	h=200mm	<p>A: 100mm</p> <p>D: 200 mm</p>	P
A and B	h=100mm								
C	h=150mm								
D	h=200mm								
	The heights of the fall determined by the part of the sample which projects most from the mounting surface is applied on all parts of the sample, with the exception of parts A.		P						
	The samples are subjected to strikes which are evenly distributed over the samples. The strikes are not applied to "knock-out" areas.		P						
	<p>The following blows are applied:</p> <p>— for parts A, five strikes: one in the centre. After the sample has been moved horizontally: one each on the unfavourable points between the centre and the edges; and then, after the sample has been turned 90° about its axis perpendicular to the plywood, one each on similar points;</p> <p>— for parts B (as far as applicable), C and D, four blows: one on one side of the sample after the plywood sheet has been turned 60° and one blow on another side of the sample after it has been turned 90° about its axis perpendicular to the plywood sheet, keeping the position of the plywood sheet unchanged;</p> <p>one blow on each of the other two sides of the sample, with the plywood sheet turned 60° in the opposite direction.</p>		P						

Clause	Requirement - Test	Result - Remark	Verdict
	<p>After the test, the sample shall show no damage within the meaning of the standard. In particular, live parts shall not become accessible with the standard test finger.</p> <p>Damage to the finish, small dents which do not reduce creepage distances or clearances and small chips which do not adversely affect the protection against electric shock or harmful ingress of water are neglected.</p> <p>Cracks, not visible with the normal or corrected vision, without additional magnification, and surface cracks in fibre reinforced mouldings and the like, are ignored.</p>	No damaged afer the test	P
7.9.2.2	Portable SPDs are tested in a tumbling barrel as shown in Figure 12.	Fixed SPD	N/A
	Rewireable SPDs are fitted with the flexible cable or cord specified by the manufacturer and a free length of approximately 100 mm.		N/A
	Terminal screws and assembly screws are tightened with a torque equal to two-thirds of that specified in Table 12.		N/A
	Non-rewireable SPDs are tested as delivered, the flexible cable or cord being cut so that a free length of about 100 mm projects from the accessory.		N/A
	<p>The samples fall from a height of 500 mm onto a steel plate, 3 mm thick, the number of falls being the following:</p> <p>—1 000 if the mass of the sample without cable or cord does not exceed 100 g;</p> <p>—500 if the mass of the sample without cable or cord exceeds 100 g, but does not exceed 200 g;</p> <p>—100 if the mass of the sample without cable or cord exceeds 200 g.</p>		N/A
	The barrel is turned at a rate of five revolutions per minute, ten falls per minute thus taking place. Only one sample is tested in the barrel at a time.		N/A
	<p>After the test, the samples shall show no damage. In particular</p> <p>—no part shall have become detached or loosened,</p> <p>—it should not be possible to touch any live parts, even if the standard test finger is applied with a force not exceeding 10 N.</p>		N/A
	During the examination after the test, special attention is paid to the connection of the flexible cable or cord. Small pieces may be broken off without rejection, provided that the protection against electric shock is not affected.		N/A
	Damage to the finish and small dents which do not reduce the creepage distances or clearances are neglected.		N/A
	Class I and II SPD To avoid overstress of the samples, the test of 7.5.2 is performed only at $I_n$		N/A
	Class I and II SPD with switching component: Test of 7.5.3 the sparkover voltage, measured limiting voltage (five of positive and five of negative polarity) should less than $U_P$ .		N/A

Clause	Requirement - Test	Result - Remark	Verdict
	Class III SPD Test of 7.5.4 or 7.5.5 needs to be carried out at $U_{oc}$ only, four surges will be applied to the SPD at each amplitude: two of positive and two of negative polarity		N/A
	The sample has passed the test if the measured limiting voltage is below or equal to $U_p$ .		N/A
	The test sample is then connected to a voltage source with a maximum continuous operating voltage ( $U_c$ ) at the rated frequency. The test transformer shall have a short-circuit current capability of at least 200 mA, unless other values are provided by the manufacturer. Once thermal stability is achieved, either: the current, which flows through the test sample, is measured. Its resistive component (measured at the crest of the sine wave) shall not exceed a value of 1 mA; or the stand-by power consumption shall not increase by more than 20 % of the value measured in 7.7.5		N/A
6.5.1.3/7.9.7	<b>Insulation resistance</b>		P
	This test is not applicable to SPDs having a metallic enclosure connected to protective earth.	Plastic enclosure	N/A
7.9.7.1	Additional entry holes for cables – if there are any – are left open; if there are any knock outs, one of them is opened. Coverings and other parts, detachable without tools, are removed and – if necessary – undergo the same moisture treatment.	Without Additional entry holes	N/A
	The moisture treatment is carried out in a humidity cabinet with a relative humidity between 91 % and 95 %. The air temperature is kept at all points, where the test sample can be positioned, within $\pm 1$ K at a suitable value $T$ between 20 °C and 30 °C. Before putting the test samples into the humidity cabinet, they shall have a temperature between $T$ and $(T+4)$ in °C. The test samples shall be kept in the humidity cabinet for 2 days (48 h).	RH 93%, 25°C, 48 h	P
7.9.7.2	After a delay of between 30 min and 60 min following the humidity treatment, the insulation resistance is measured 60 s after having applied a d.c. voltage of 500 V.	Test voltage is 500VDC	P
	This measurement is carried out in the humidity cabinet or in the room into which the specimens were brought to reach the determined temperature, after having fixed again the parts which might have been detached. The measuring has to be done as follows:		P

Clause	Requirement - Test	Result - Remark	Verdict
	<p>a) between all interconnected live parts and the SPDs body accessible to accidental contact The expression "body" in the sense of this test means</p> <p>— all touchable metal parts and a metal foil on surfaces of insulating material, which are touchable after installation as for normal use,</p> <p>— the surface on which the SPD is mounted, if necessary, covered with metal foil,</p> <p>— screws and other facilities for fastening the SPD on its support.</p> <p>For these measurements, the metal foil is put on in such a way, that perhaps existing casting mass is effectively tested.</p> <p>Protective components connected to PE may be disconnected for this test.</p>	Detail see below	P
	<p>b) between the live parts of the SPD main circuit and live parts of auxiliary circuits, if there are any. The insulation resistance shall not be lower than 5 M<math>\Omega</math>—for the measurements according to a) 2 M<math>\Omega</math>—for the measurements according to b).</p>	<p>a) between all interconnected live parts and the SPDs body accessible to accidental contact The expression "body" in the sense of this test means &gt;1000 M<math>\Omega</math></p>	P
6.2.10 / 7.9.8	<b>Dielectric withstand</b>		P
	SPDs classified for outdoor use are tested between the terminals with the internal parts removed. During this test, the SPD is subjected to sprinkling according to 9.1 of GB/T 16927.1.		N/A
	SPDs category indoor are tested as indicated in a) and b) of 7.9.7.2.	Indoor SPD	P
	SPDs are tested with an a.c. voltage according to Table 16. Starting with not more than half the required a.c. voltage, this voltage is increased to the full value within 30 s which is then held for 1 min.		P
	<p>a) between all interconnected live parts and the SPDs body accessible to accidental contact The expression "body" in the sense of this test means</p> <p>— all touchable metal parts and a metal foil on surfaces of insulating material, which are touchable after installation as for normal use,</p> <p>— the surface on which the SPD is mounted, if necessary, covered with metal foil,</p> <p>— screws and other facilities for fastening the SPD on its support.</p> <p>For these measurements, the metal foil is put on in such a way, that perhaps existing casting mass is effectively tested.</p> <p>Protective components connected to PE may be disconnected for this test.</p> <p>b) between the live parts of the SPD main circuit and live parts of auxiliary circuits, if there are any. The insulation resistance shall not be lower than.</p>	<p>U<sub>c</sub>=385 Vac</p> <p>a) between all interconnected live parts and the SPDs body accessible to accidental contact The expression "body" in the sense of this test means Test voltage: 2.2kV</p>	P
	Arcing or puncturing shall not occur, however, partial discharges are accepted if the voltage change during the discharge is less than 5 %.	No arcing and pincturing	P
	Auxiliary circuits are tested according to GB 14048.5	Without auxiliary circuits	N/A

Clause	Requirement - Test	Result - Remark	Verdict
7.9.9	<b>Resistance to ingress of solid objects and to harmful ingress of water</b>		P
	Testing shall be carried out in accordance with IEC 60529 to check the IP code.	IP20	P
6.5.1.2 / 7.9.3	<b>Heat resistance</b>		P
7.9.3.1	For 1 h the SPD is kept in a heating cabinet at a temperature of 100 °C ± 2 K.	100°C, 1 h	P
	Any sealing compound used in the internal assembly shall not flow out to any significant extent.	No significant extent.	P
	After cooling, it should not be possible to touch any live parts when the test sample is mounted as for normal use even if the standard test finger is applied with a force not exceeding 5 N.		P
7.9.3.2	Outer parts of SPDs, consisting of insulating material, are submitted to a ball thrust test by means of a tester as shown on Figures 12a and 12b.		P
	Parts of insulating material necessary to retain current carrying parts and parts of the earthing circuit in position are tested in a heating cabinet at 125 °C ± 2 K.	Test at 125°C	P
	Parts of insulating material not necessary to retain current carrying parts and parts of the earthing circuit in position, even though they are in contact with them, are tested at 70 °C ± 2 K.		N/A
	The sample to be tested is fastened accordingly, its surface being positioned horizontally; a steel ball having a diameter of 5 mm is pressed against the surface with a force of 20 N. After 1 h, the steel ball is taken away from the sample; by dipping it into cold water, the temperature of the sample is reduced to ambient temperature within 10 s.		P
	The diameter of the ball indentation is measured and shall not exceed 2 mm.	measured 0.8 mm	P
6.2.8 / 7.9.5	<b>Verification of air clearances and creepage distances</b>		P
	The electrode spacing of spark gaps shall not be considered for the determination of air clearances and creepage distances.		P
7.9.5.1	<b>SPDs category outdoor</b>	Indoor SPD	N/A
	Between live parts and earth, the air clearances and creepage distances shall not be smaller than the values indicated in Table 14.		N/A
7.9.5.2	<b>SPDs category indoor</b>		P
	Air clearances and creepage distances shall not be smaller than the values indicated in Table 15.	Uc=385Vac	P
	Air clearances in millimetres 1) Between live parts of different polarity	10.43mm > 3mm (Requirement)	P
	2) Between live parts and —screws and other means to fasten a covering, having to be detached for mounting the SPD		N/A
	—fastening surfaces	46.55mm > 6mm(Requirement)	P
	—screws or other means for fastening the SPD		N/A

Clause	Requirement - Test	Result - Remark	Verdict
	—bodies	6.26mm > 3mm(Requirement)	P
	3) Between the metal parts of the disconnecter mechanism and —bodies		N/A
	—screws or other means for fastening the SPD		N/A
	<b>Creepage distances in millimetres</b> 4) Between live parts of different polarity	22.82mm > 3mm(Requirement)	P
	5) Between live parts and —screws and other means to fasten a covering, having to be detached for mounting the SPD		N/A
	—screws or other means for fastening the SPD		N/A
	—bodies	6.92mm > 3mm (Requirement)	P
7.9.5.2.1	The whole distance, namely the sum out of air gap and the distance through the separating surface, is taken as air clearance.		P
	If metal parts are covered with self-hardening resin of a least 2 mm thickness, or if they are covered with an insulation, withstanding a test voltage according to 7.9.8, creepage distances and air clearances are not necessary.	No such metal	N/A
7.9.5.2.2	The casting shall not come over the rim of the deepening, it shall stick strongly to the walls of the cavity and the metal parts in it.		N/A
	Testing: examination and trial to detach the casting mass without a tool.		N/A
6.2.9/7.9.6	<b>Tracking resistance</b>	See below	N/A
	Testing is not applicable in case of insulating materials made out of ceramic or		N/A
	if the creepage distances are at least equal to double the values indicated in 7.9.5.		P
	Testing according to IEC 60112, solution A with a test voltage of 175 V.		N/A
6.5.2/7.9.4	<b>Resistance to abnormal heat and fire</b>	See below	P
	The glow wire test is performed in accordance with clauses 4 to 10 of GB/T 5169.10 under the following conditions:		P
	—for external parts of SPDs made of insulating material necessary to retain in position current-carrying parts and parts of the protective circuit, by the test made at a temperature of 850 °C ± 15 K;	Test temperature 850°C.	P
	—for all other external parts made of insulating material, by the test made at a temperature of 650 °C ± 10 K. For the purpose of this test, bases of surface-type SPDs are considered as external parts. The test is not made on parts of ceramic material. If the insulating parts are made of the same material, the test is carried out only on one of these parts, according to the appropriate glow-wire test temperature.		N/A
	The sample shall be positioned during the test in the most unfavourable position of its intended use (with the surface tested in a vertical position).		P

Clause	Requirement - Test	Result - Remark	Verdict
	The tip of the glow-wire shall be applied to the specified surface of the test sample taking into account the conditions of intended use under which a heated or glowing element may come into contact with the sample.		P
	The sample is regarded as having passed the glow-wire test if —there is no visible flame and no sustained glowing, or if —flames and glowing parts on the sample extinguish themselves within 30 s after the removal of the glow-wire.	flames and glowing parts on the sample extinguish themselves within 30 s after the removal of the glow-wire.	P
	There shall be no ignition of the tissue paper or scorching of the pinewood board.	no ignition of the tissue paper or scorching of the pinewood board	P
6.4	<b>Environmental requirements</b>	Indoor SPD	N/A
	Outdoor SPDs shall be contained in a weather shield of glass, glazed ceramic or other acceptable material that is resistant to UV radiation, corrosion, erosion, and tracking.		N/A
Remark:			



Clause	Requirement - Test	Result - Remark	Verdict
<b>TEST SERIES 9</b>			
6.6/7.8	<b>Test for two-port SPDs and one-port SPDs with separate input/output terminals</b>	One port SPD	N/A
6.6.1/7.8.1	<b>Test to determine the percentage voltage regulation</b>		N/A
	A voltage $U_c$ is supplied at the input port and shall be constant within $-5\%$ . The test shall be conducted with rated load current into a resistive load. Input and output voltage shall be measured simultaneously with load connected. Use the following formula to determine the percentage voltage regulation, $\Delta U$ : $\Delta U\% = [(U_e - U_s) / U_e] 100\%$		N/A
	This value shall be recorded and comply with the manufacturer's declaration.		N/A
6.6.3/7.8.4	<b>Load-side surge withstand capability</b>	One port SPD	N/A
	Only applicable to the two-port SPD claimed by the customer		N/A
	For this test: —15 current impulses 8/20, —or 15 combination wave impulses with an open-circuit voltage $U_{oc}$		N/A
	with a value equal to the load-side surge withstand capability declared by the manufacturer are applied in three groups of five impulses to the output port of the test sample. The SPD is energized at $U_c$ by means of a voltage source having a nominal current of at least 5 A. Each impulse shall be synchronized to the power frequency. Starting from $0^\circ$ the synchronization angle shall be increased in steps of $30^\circ \pm 5^\circ$ .		N/A
	The interval between the impulses is 50 s to 60 s and the interval between the groups is 25 min to 30 min.		N/A
	The test sample shall be energized during the whole test sequence. The voltage on the output terminals shall be recorded.		N/A
7.6.6	<b>Pass criteria</b>	One port SPD	N/A
	thermal stability is achieved after each impulse of the operating duty tes		N/A
	any follow current is self-extinguished		N/A
	Both the voltage and current records, together with a visual inspection, shall show no indication of puncture or flashover of the samples.		N/A
	Mechanical damage shall not occur during these tests.		N/A
	One more impulse at $I_n$ or $U_{oc}$ shall be applied to the SPD while energized at $U_c$ by means of a voltage source having a nominal current capability of at least 5 A. After this impulse, $U_c$ remains applied and thermal stability shall be achieved within 30 min.		N/A

Clause	Requirement - Test	Result - Remark	Verdict
	Once thermal stability is achieved, either: —the current, which flows through the test sample, is measured. Its resistive component (measured at the crest of the sine wave) shall not exceed a value of 1 mA; or —the stand-by power consumption shall not increase by more than 20 % of the value measured in 7.7.5.		N/A
	Class I and II SPD To avoid overstress of the samples, the test of 7.5.2 is performed only at $I_n$		N/A
	Class I and II SPD with switching component: Test of 7.5.3 the sparkover voltage, measured limiting voltage (five of positive and five of negative polarity) should less than $U_p$ .		N/A
	Class III SPD Test of 7.5.4 or 7.5.5 needs to be carried out at $U_{oc}$ only, four surges will be applied to the SPD at each amplitude: two of positive and two of negative polarity		N/A
	the values measured before and after the test are below or equal to $U_p$ .		N/A
6.6.2/7.8.2	The SPD shall be powered, as in 7.8.1 at ambient temperature using a cable with the minimum cross-sectional area specified in 7.3.1. The load current shall be set to the rated load current specified by the manufacturer.		N/A
	The SPD passes the test if the enclosure has reached thermal stability and the temperature of the parts which are accessible in normal use shall be not more than 40 K above the ambient temperature of the room (see 2.1).		N/A
7.8.5	<b>Overload behaviour</b>	One port SPD	N/A
	This test is performed on all two-port SPDs, but shall only be performed on one-port SPDs if the internal connections between input and output terminals have a smaller cross-section than the conductors specified to perform the test.		N/A
	The test is carried out at ambient temperature and the sample shall be protected against abnormal external heating or cooling.		N/A
	The test circuit and procedure shall be as described in 7.8.2, except that circuits other than the main circuit and the temperature rise are disregarded for this test.		N/A
	The test is performed without any external overcurrent protective devices being connected (internal removable overcurrent protective devices are replaced by a link of negligible impedance).		N/A
	If a maximum overcurrent protection is specified by the manufacturer, the SPD shall be loaded for 1 h with a current equal to $k$ times that maximum overcurrent protection. The factor $k$ shall be selected from Table 11x, depending on national installation rules.		N/A

Clause	Requirement - Test	Result - Remark	Verdict
	If no maximum overcurrent protection is specified by the manufacturer, the SPD shall be loaded with 1,1 times the rated load current for 1 h or until an internal disconnecter operates. If no disconnecter operates within 1 h, the test is continued by increasing the previous value of test current by a factor of 1,1 every hour, until an internal disconnecter operates.		N/A
	<b>Pass criteria</b>		N/A
	For touchable surfaces, the temperature rise shall always be less than 60 K during the test.		N/A
	a) No internal disconnecter has operated: — Visual inspection of the test sample shall reveal no evidence of any damage. — SPDs having an IP degree equal or greater than IP20 shall not have live parts accessible with the standardized test finger applied with a force of 5 N (see IEC 60529), except for those live parts which were already accessible before the test when the SPD is fitted as in normal use. — The test sample is then connected to $U_C$ . The test transformer shall have a short-circuit current capability of at least 200 mA. The current, which flows through the test sample, is measured. Its resistive component (measured at the crest of the sine wave) shall not exceed a value of 1 mA or — the stand-by power consumption shall not increase by more than 20 % of the value measured in 7.7.5		N/A
	Class I and II SPD To avoid overstress of the samples, the test of 7.5.2 is performed only at $I_n$		N/A
	Class I and II SPD with switching component: Test of 7.5.3 the sparkover voltage, measured limiting voltage (five of positive and five of negative polarity) should less than $U_P$ .		N/A
	Class III SPD Test of 7.5.4 or 7.5.5 needs to be carried out at $U_{oc}$ only, four surges will be applied to the SPD at each amplitude: two of positive and two of negative polarity		N/A
	If the measured voltage value is less than or equal to $U_P$ , the test is passed		N/A
	Auxiliary circuits, such as status indicators, shall be in working order.		N/A
7.8.3	<b>Load-side short-circuit withstand capability test in conjunction with SPD disconnectors</b>	One port SPD	N/A
	The test, according to 7.7.3, is repeated without short-circuiting any components but by short-circuiting all load terminals with a conductor of the largest cross-section specified under 7.3.1 and of length 500 mm.		N/A
	<b>Pass criteria</b>		N/A

Clause	Requirement - Test	Result - Remark	Verdict
	During the test the power short-circuit current shall be interrupted within 5 s. During the test the muslin paper, or cheesecloth, shall not catch fire. In addition, there shall be no explosion or hazard for either personnel or facilities.		N/A
	<b>Accessible SPDs</b>		N/A
	After the test, SPDs having an IP degree equal to, or greater than, IP2X shall not have live parts accessible with the standardized test finger applied with a force of 5 N (see GB 4208).		N/A
	If no internal disconnecter has operated, the SPD shall fulfil the requirements according to 7.4.1 and 7.5.		N/A
7.4.1	The sample is mounted as for normal use and the test is conducted using conductors of the smallest cross-sectional area and then again using conductors of the largest cross-sectional area as specified in 7.3.1.		N/A
	The standard test finger (in accordance with GB 4208) is applied in every possible position.		N/A
	For plug-in SPDs (which can be changed without a tool), the test finger is applied in every possible position, when the plug is partially engaged or completely engaged with a socket outlet.		N/A
	An electrical indicator with a voltage of not less than 40 V and not more than 50 V is used to show contact with the relevant part.		N/A
7.5	Class I and Class II SPDs test of 7.5.2		N/A
	Class I and Class II SPDs with switching components test of 7.5.3		N/A
	Class III SPD test of 7.5.4 or 7.5.5		N/A
	All one-port SPDs shall be tested unenergized.		N/A
	All two-port SPDs are to be tested energized by means of a voltage source having a nominal current of at least 5 A at $U_c$		N/A
	For a one-port SPD having terminals, the test is performed without external disconnectors and the measured limiting voltage is measured at the terminals. For a one-port SPD having connecting leads, the measured limiting voltage is measured with an external lead length of 150 mm.		N/A
	For a two-port SPD, and a one-port SPD having separate load terminals, the measured limiting voltage is measured at the load port or load terminals of the SPD.		N/A
	The measured limiting voltage is the highest voltage value of the tests		N/A
7.5.2	<b>measure the residual voltage with 8/20 current impulses</b>		N/A
	current impulses shall be used with a sequence of peak values of approximately 0.1 $I_n$ 0.2 $I_n$ 0.5 $I_n$ 1.0 $I_n$		N/A
	One sequence of positive polarity and one sequence of negative polarity are applied to the SPD.		N/A

Clause	Requirement - Test	Result - Remark	Verdict
	Finally, at least one impulse of $I_{max}$ or $I_{peak}$ providing $I_{max}$ or $I_{peak}$ is above $I_n$ is applied to the SPD at the polarity that showed higher residual voltages in previous tests.		N/A
	The interval between individual impulses shall be long enough for the sample to cool down to ambient temperature.		N/A
	A current and a voltage oscillogram shall be recorded for each impulse.		N/A
	A curve which best fits the data points shall be drawn.		N/A
	The residual voltage used for determining the measured limiting voltage is given by definition as the highest voltage on this curve corresponding in the range of currents for: —class I: up to $I_{peak}$ or $I_n$ whichever is greater; —class II: up to $I_n$ .		N/A
7.5.3	<b>measure the front-of-wave sparkover voltage</b>		N/A
	The 1,2/50 voltage impulse is used. The generator voltage is set to an open circuit output voltage of 6 kV.		N/A
	10 impulses are applied to the SPD, five of positive and five of negative polarity.		N/A
	The interval between individual impulses shall be long enough to allow the sample to cool down to ambient temperature.		N/A
	If sparkover is not observed during any of the 10 impulses on the front of the wave, then a) and b) above are repeated with a generator open circuit output voltage of 10 kV.		N/A
	The voltage at the SPD shall be recorded with an oscilloscope.		N/A
	The measured limiting voltage is the maximum value of the sparkover voltages recorded during the whole test sequence.		N/A
7.5.4	<b>measure the limiting voltage with the combination wave</b>		N/A
	The combination wave will be applied to an energized SPD, with the mains voltage at $U_c$ .		N/A
	For SPDs rated <i>only</i> on a.c. power systems, positive impulses are applied at the $90^\circ \pm 10^\circ$ point and negative impulses at $270^\circ \pm 10^\circ$ point on the sinusoidal voltage waveform.		N/A
	For SPDs rated for use on d.c. systems, both positive and negative impulse surges are applied. The SPD will be energized at the d.c. $U_c$ .		N/A
	The interval between the individual impulses shall be long enough for the sample to cool down to ambient temperature.		N/A
	The voltage of the combination wave generator is set to provide an open-circuit voltage of 0.1 $U_{oc}$ 0.2 $U_{oc}$ 0.5 $U_{oc}$ 1.0 $U_{oc}$		N/A
	With these generator settings four surges will be applied to the SPD at each amplitude: two of positive and two of negative polarity.		N/A

Clause	Requirement - Test	Result - Remark	Verdict
	An oscillographic record shall be made of the current delivered by the generator into the SPD and the voltage at the output port of the SPD for each impulse.		N/A
	The measured limiting voltage is the maximum magnitude of the peak voltage recorded during the whole test sequence.		N/A
	If an SPD internal disconnecter has operated, there shall be clear evidence of effective and permanent disconnection. In checking for disconnection take the following steps: a) confirm that there is no voltage on the output terminals; b) pply a power-frequency voltage equal to two times $U_c$ between the corresponding input and output terminals for 1 min without current flow in excess of 0,5 mA r.m.s.		N/A
	The test shall include all the auxiliary parts in series with the SPD as declared by the manufacturer.		N/A
Remark:			

Clause	Requirement - Test	Result - Remark	Verdict
<b>TEST SERIES 10</b>			
6.2.12	<b>Status indicator operation</b>		P
	Throughout the entire type testing procedure, the status shown by the indicator(s) shall give a clear sign of the status of the part to which it is linked. For an SPD with a stated intermediate status indication, the intermediate status is not considered as a failure of the indicator. Where there is more than one method of status indication, for example local and remote indication, each type of indication shall be checked. The manufacturer shall provide information about the function of the indicator and the actions to be taken after change of status indication.		P
	A status indicator may be composed of two parts linked by a coupling mechanism which can be mechanical, optical, audio, electromagnetic, etc. One part is replaced on replacement of the SPD and shall be tested as above. The other part is not replaced on the replacement of the SPD and shall additionally be capable of operating at least 50 times.		N/A
	The action of the coupling mechanism which operates the non-replaced part of the status indicator, may be simulated by means other than operation of the section within the replaced part of the SPD, for example, a separate electromagnet or a spring.		N/A
	Where there is an appropriate standard for the type of indication used, this shall be met by the non-replaced part of the status indicator, with the exception that the indicator need only be tested for 50 operations.		N/A
6.2.13	<b>Isolation between separate circuits</b>		N/A
	Where an SPD includes a circuit which is electrically isolated from the main circuit, the manufacturer shall provide information about the isolation and dielectric withstand voltages between the circuits as well as the relevant standards with which he is claiming conformity.		N/A
	Where there are more than two circuits, declarations shall be made with regard to each combination of circuits.		N/A
	The isolation and dielectric withstand of the separate circuits shall be tested according to the manufacturer's declaration.		N/A
Remark:			

Figure — Operating duty test

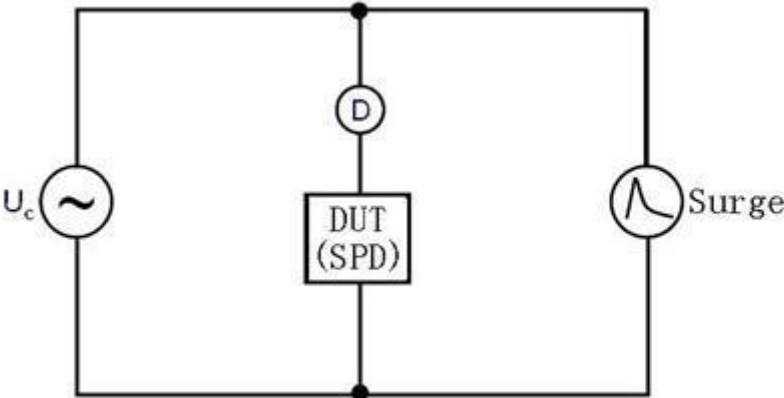

$U_c$ : Power

Surge:  $I_{imp}$ ,  $I_{max}$ ,  $I_n$  and  $U_{oc}$

D: External SPD disconnect

DUT: Test sample





### Test Equipment Form

Name	Manufacturer	Model	Equipment No.	Calibration Date	Effective Date
Impulse current generator	Grandtop	GIC200D100C	LNP-SB-001	2020/8/28	2021/8/27
Multi-function AC test power supply	Grandtop	TOVLH4	LNP-SB-003	2020/8/28	2021/8/27
AC thermal stability tester	Grandtop	TTS2/1200	LNP-SB-004	2020/8/28	2021/8/27
AC Power	Grandtop	GPAC100/1000	LNP-SB-006	2020/8/28	2021/8/27
Dielectric strength tester	Grandtop	/	LNP-SB-010	2020/4/27	2021/4/26
Temp. & Hum. chamber	Tianhai	TH8046-408	LNP-SB-011	2020/11/25	2021/11/24
Ageing oven	Tianhai	TH8011A	LNP-SB-012	2020/7/30	2021/7/30
Glow-wire test equipment	Tianhai	TH8055	LNP-SB-013	2020/11/25	2021/11/24
Tracking Test Apparatus	Tianhai	TH8058	LNP-SB-014	2020/11/25	2021/11/24
Ball Press Tester	Tianhai	TH8088	LNP-SB-015	2020/11/25	2021/11/24
Test pin	Tianhai	/	LNP-SB-016	2020/11/25	2021/11/24
Test finger	Tianhai	/	LNP-SB-017	2020/11/25	2021/11/24
LCR meter	Victor	VC4090A	LNP-SB-018	2020/4/27	2021/4/26
Infrared thermometer	FLUKE	FLUKE-59	LNP-SB-020	2020/11/25	2021/11/24
Torque screwdriver	EXPLOIT	EXPLOIT	LNP-SB-021	2020/11/25	2021/11/24
Multimeter	FLUKE	17B+	LNP-SB-022	2020/11/25	2021/11/24
Clamp meter	UNI-T	UT204A	LNP-SB-024	2020/11/25	2021/11/24
Digital Caliper	GUANGLU	/	LNP-SB-025	2020/11/25	2021/11/24
Push-pull gauge	AIDEBAO	NK-500	LNP-SB-026	2020/11/25	2021/11/24
Stopwatch	Tianfu	PC396	LNP-SB-027	2020/11/25	2021/11/24
Clock	Polaris	A2789	LNP-SB-028	2020/11/25	2021/11/24
Hygrothermograph	DELI	8958	LNP-SB-029	2020/11/25	2021/11/24
Hygrothermograph	DELI	8958	LNP-SB-030	2020/11/25	2021/11/24
Hygrothermograph	DELI	8958	LNP-SB-031	2020/11/25	2021/11/24
Pendulum impact-tester	TIANHAI	BC-1	LNP-SB-034	2020/7/30	2021/7/29
N-hexane	XINDUO	/	LNP-SB-048	/	/

Annex 1  
Measure limiting voltage

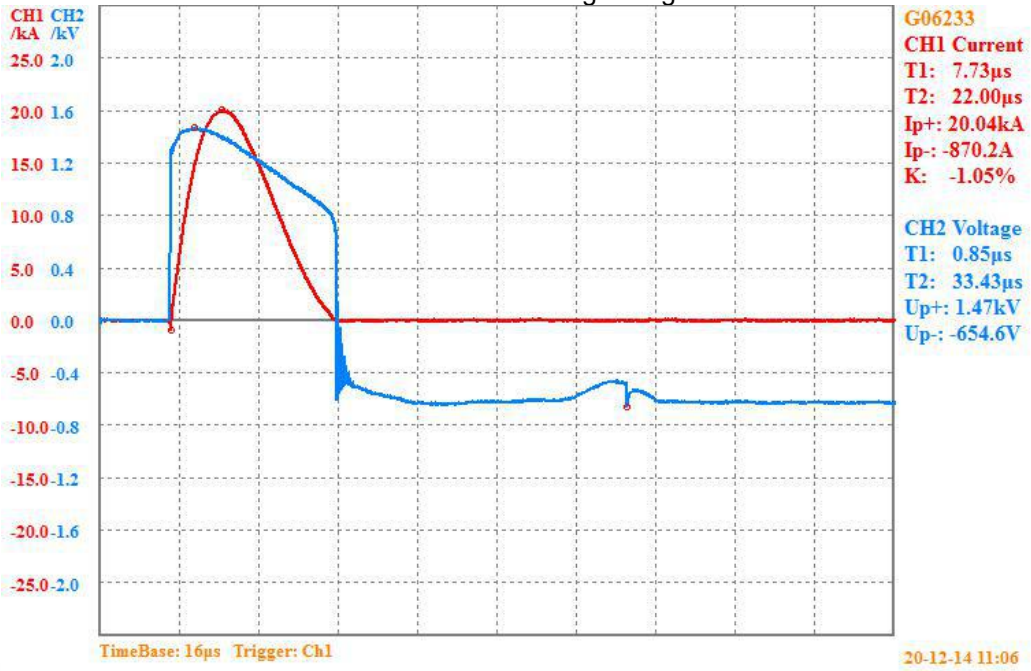

Annex 2  
Measure limiting voltage

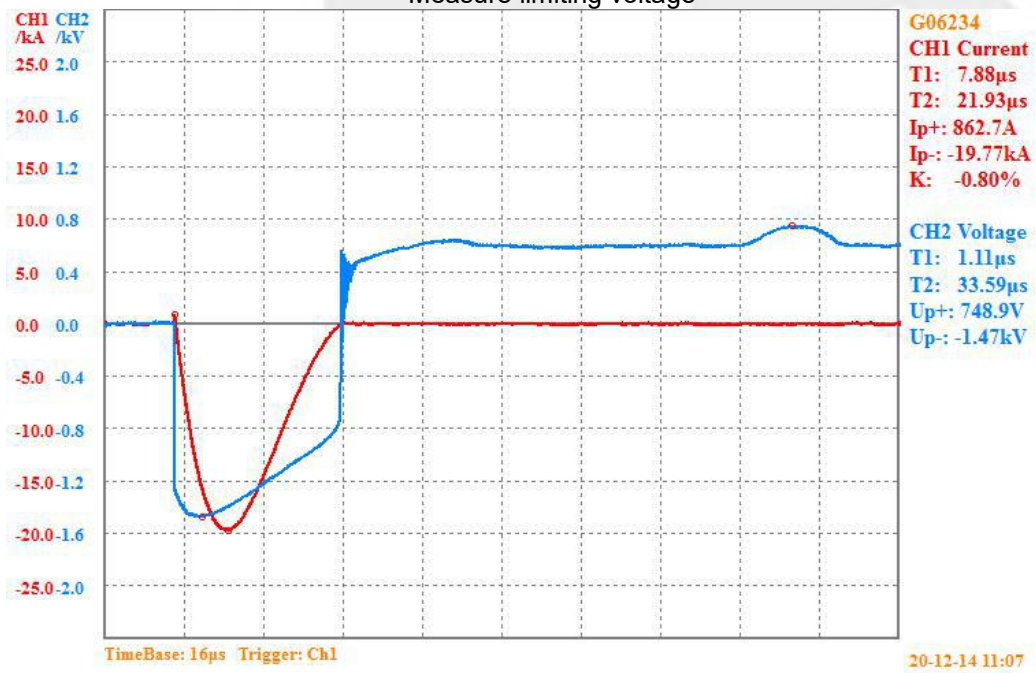

Annex 3



Annex 4  
Thermal stability test

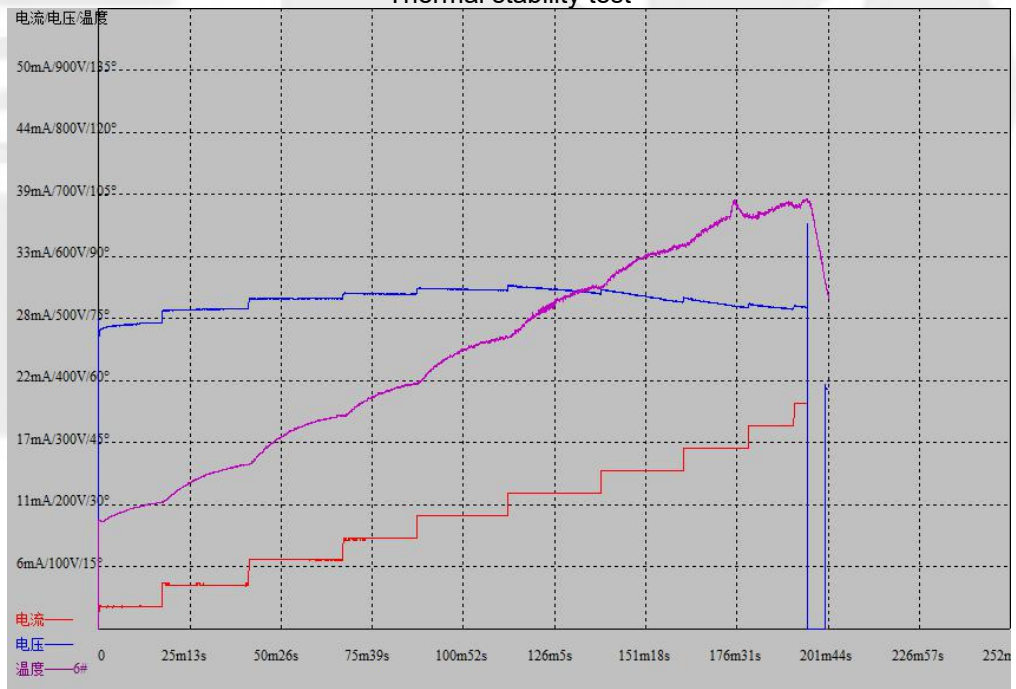

BLOW BLANK

